

THE DOCUMENT/DRAWING IS INTELLECTUAL PROPERTY OF THE AUTHORS. TRANSMITTING OR COPYING, TOTALLY OR PARTIALLY, WITHOUT WRITTEN APPROVAL OF THE AUTHORS REPRESENT A BREACHING OF THE LAWFUL RIGHTS.

 		PROEX INSTAL CONSULTING RO36670168.J51/504/2016 proexinstalconsulting@gmail.com		<b>INCADRAREA IN ZONA</b>  Reducerea emisiilor de gaze cu efect de sera prin eficientizarea sistemului de iluminat public in comuna Gura Ocniței		Plansa nr 01
ATESTAT Be C1A		Scara:				faza
SEF PROIECT	Ing Petrache Ion	Semnatura	 		101	
PROIECTANT	Ing Dumbrava Virgil				Data	
DESENAT	Ing Coman Cosmin				10/2023	

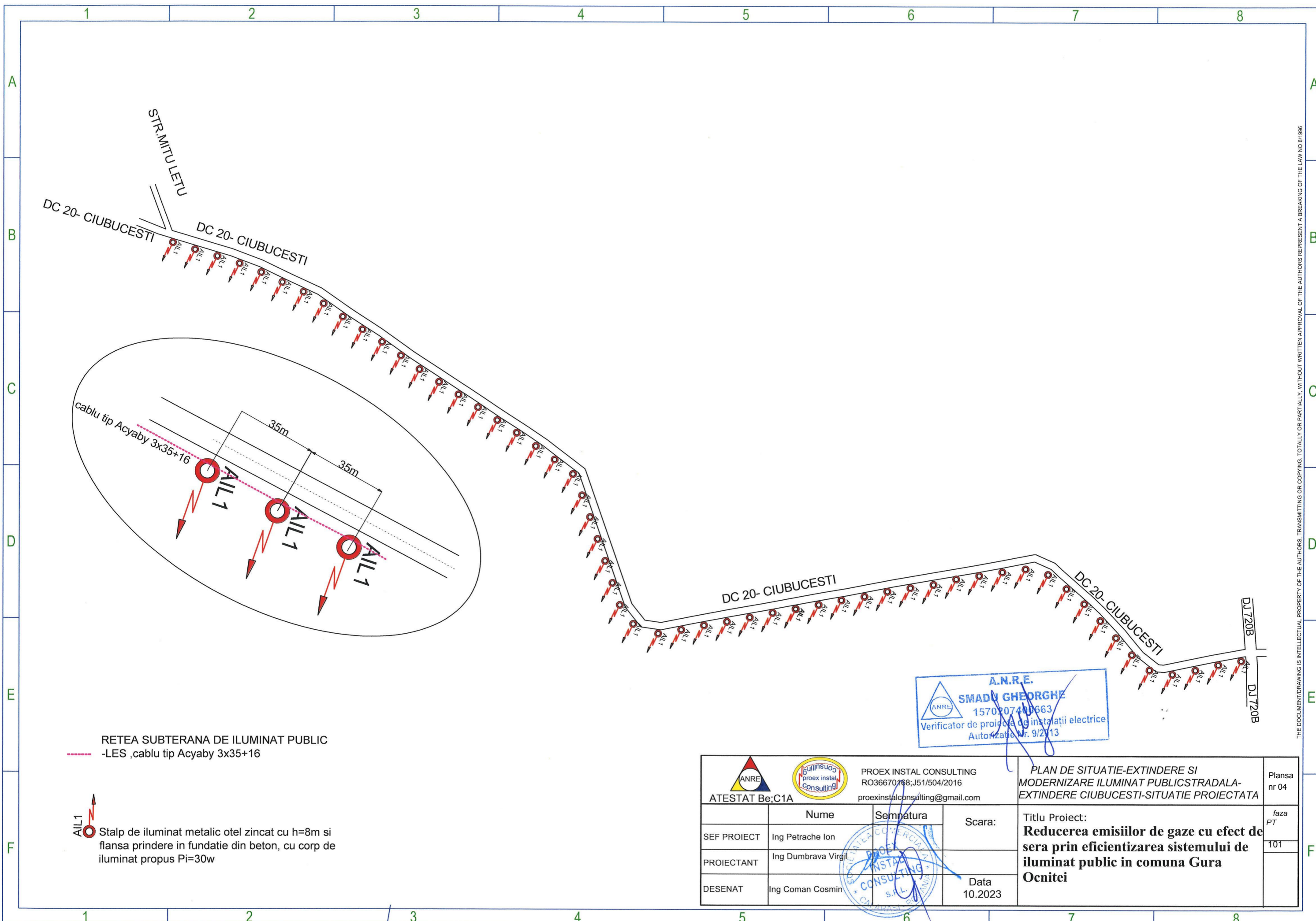





THE DOCUMENT/DRAWING IS INTELLECTUAL PROPERTY OF THE AUTHORS. TRANSMITTING OR COPYING, TOTALLY OR PARTIALLY, WITHOUT WRITTEN APPROVAL OF THE AUTHORS REPRESENT A BREAKING OF THE LAW NO 84/1998

**A.N.R.E.**  
**SMADU GHEORGHE**  
 157020740663  
 Verificator de proiecte de instalații electrice  
 Autorizație Nr. 9/2013

**RETEA SUBTERANA DE ILUMINAT PUBLIC**  
 -LES ,cablu tip Acyaby 3x35+16

**AIL1** Stalp de iluminat metalic otel zincat cu h=8m si flansa prindere in fundatie din beton, cu corp de iluminat propus Pi=30w

		PROEX INSTAL CONSULTING RO36670168;J51/504/2016 proexinstalconsulting@gmail.com		<b>PLAN DE SITUATIE-EXTINDERE SI MODERNIZARE ILUMINAT PUBLIC STRADALA-EXTINDERE CIUBUCESTI-SITUATIE PROIECTATA</b>		Plansa nr 04
ATESTAT Be;C1A				Scara:	<b>Titlu Proiect:</b> <b>Reducerea emisiilor de gaze cu efect de sera prin eficientizarea sistemului de iluminat public in comuna Gura Ocniței</b>	faza PT 101
SEF PROIECT	Ing Petrache Ion	Semnatura				
PROIECTANT	Ing Dumbrava Virgil					
DESENAT	Ing Coman Cosmin			Data 10.2023		

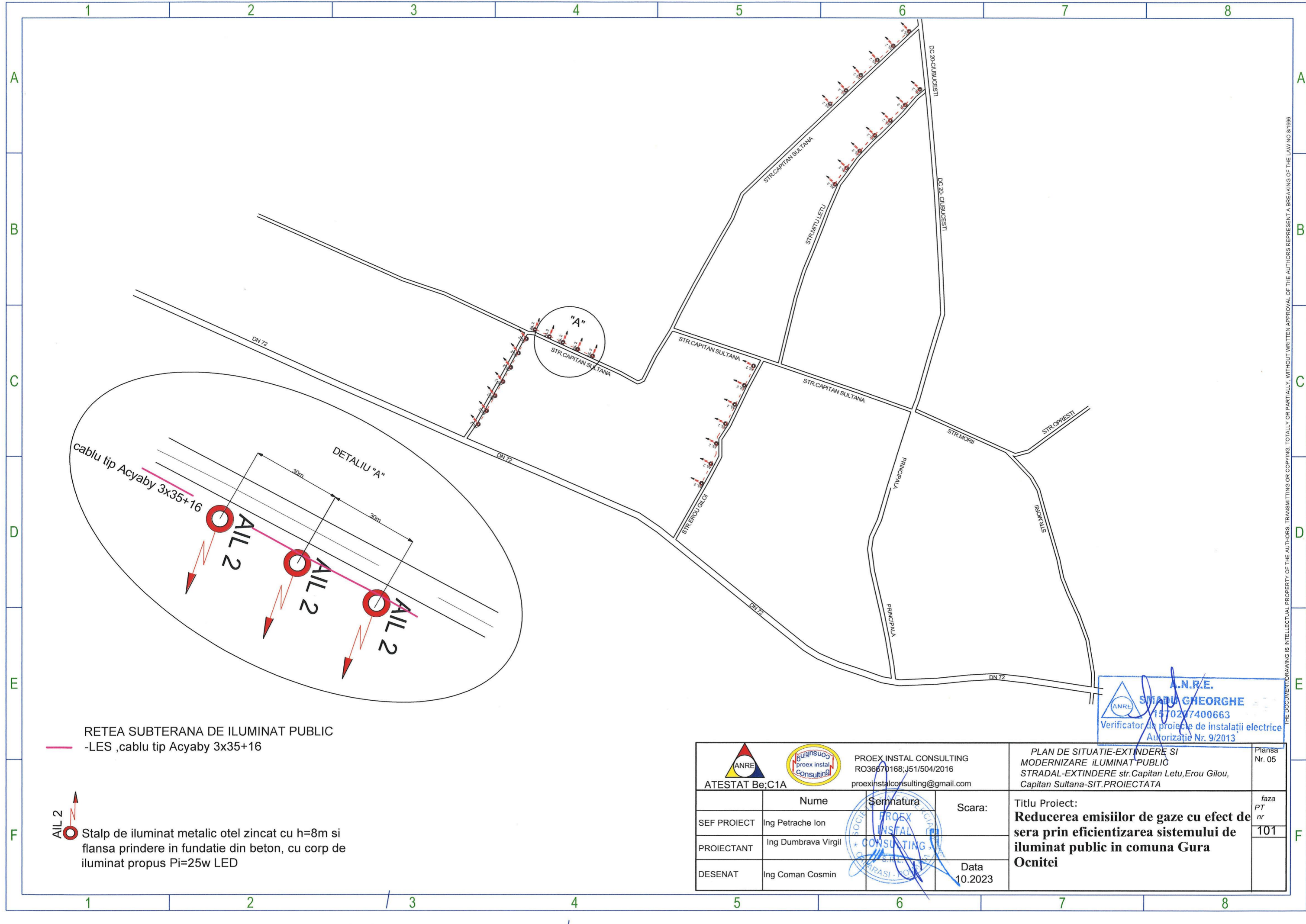

RETEA SUBTERANA DE ILUMINAT PUBLIC

-LES ,cablu tip Acyaby 3x35+16

AIL 2 Stalp de iluminat metalic otel zincat cu h=8m si flansa prindere in fundatie din beton, cu corp de iluminat propus Pi=25w LED

A.N.R.E.  
  
**STANU GHEORGHE**  
 1570207400663  
 Verificator al proiecte de instalatii electrice  
 Autorizatie Nr. 9/2013

ATESTAT Be;C1A 		PROEX INSTAL CONSULTING RO36670168;J51/504/2016 proexinstalconsulting@gmail.com	PLAN DE SITUATIE-EXTINDERE SI MODERNIZARE ILUMINAT PUBLIC STRADAL-EXTINDERE str.Capitan Letu,Erou Gilou, Capitan Sultana-SIT.PROIECTATA	Plansa Nr. 05
SEF PROIECT	Ing Petrache Ion	 SEMNATURA	Scara:	faza PT nr
PROIECTANT	Ing Dumbrava Virgil	 SEMNATURA		101
DESENAT	Ing Coman Cosmin	 SEMNATURA	Data 10.2023	

THE DOCUMENT/DRAWING IS INTELLECTUAL PROPERTY OF THE AUTHORS. TRANSMITTING OR COPYING, TOTALLY OR PARTIALLY, WITHOUT WRITTEN APPROVAL OF THE AUTHORS REPRESENT A BREAKING OF THE LAW NO #11986

# Sat Adanca, comuna Gura Ocnitei

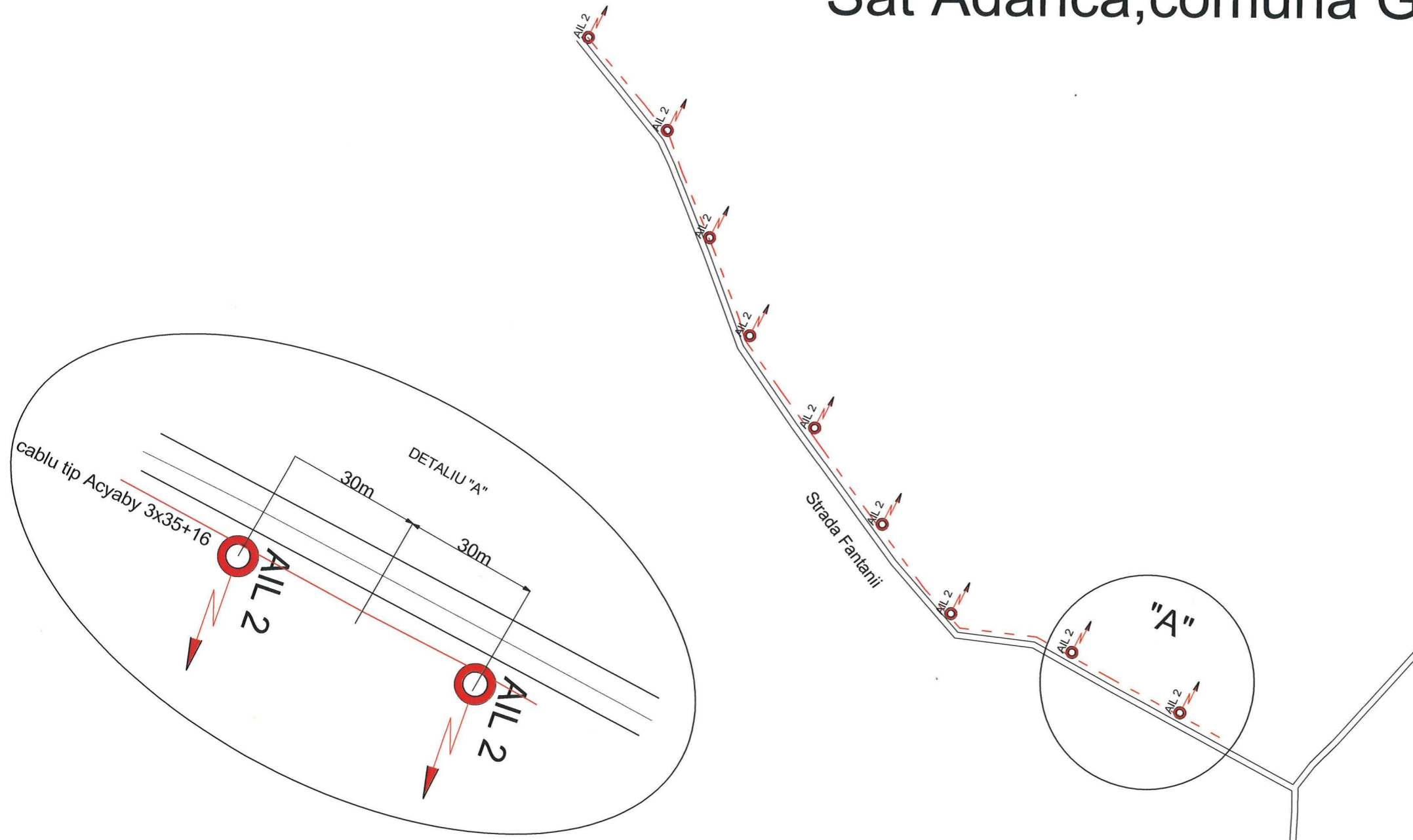

**A.N.R.E.**  
**SMANU GHEORGHE**  
 1370207400663  
 Verificator de proiecte de instalatii electrice  
 Autorizati Nr. 9/2013

RETEA SUBTERANA DE ILUMINAT PUBLIC  
 -LES ,cablu tip Acyaby 3x35+16

**AIL 2** Stalp de iluminat metalic otel zincat cu h=8m si flansa prindere in fundatie din beton, cu corp de iluminat propus Pi=25w LED

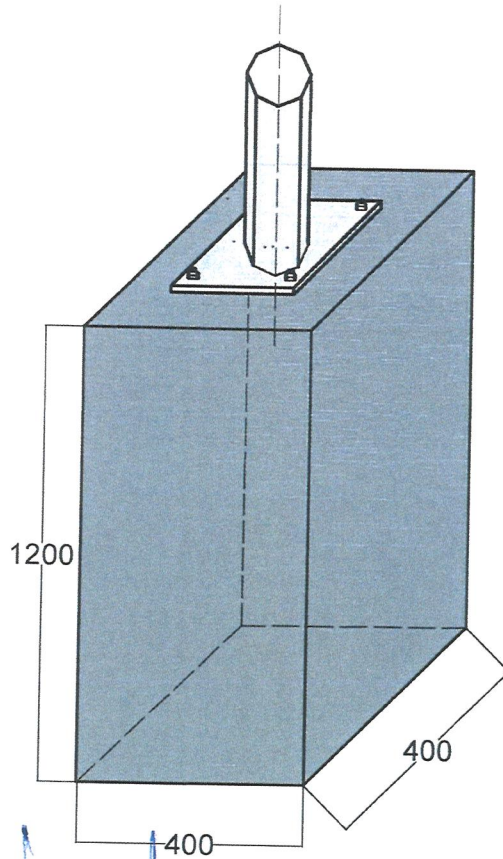

		PROEX INSTAL CONSULTING RO36670168;J51/504/2016 proexinstalconsulting@gmail.com	PLAN DE SITUATIE-EXTINDERE SI MODERNIZARE ILUMINAT PUBLIC STRADAL-EXTINDERE strada Fantanii	Plansa nr 06
ATESTAT Be;C1A				
	Nume	Semnatura	Scara:	faza PT nr
SEF PROIECT	Ing Petrache Ion			101
PROIECTANT	Ing Dumbrava Virgil			
DESENAT	Ing Coman Cosmin		Data 10.2023	
			Titlu Proiect: <b>Reducerea emisiilor de gaze cu efect de sera prin eficientizarea sistemului de iluminat public in comuna Gura Ocnitei</b>	
			Sat Adanca, comuna Gura Ocnitei	

THE DOCUMENT/DRAWING IS INTELLECTUAL PROPERTY OF THE AUTHORS. TRANSMITTING OR COPYING, TOTALLY OR PARTIALLY, WITHOUT WRITTEN APPROVAL OF THE AUTHORS REPRESENT A BREAKING OF THE LAW NO 81/1986





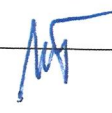

NOTA: fundatii cu urmatoarele caracteristici,  
 -beton fundatie marca B150 (C18/20)  
 -Armatura fundatie PC 52,d=12 mm  
 -Acoperire cu beton 5 cm,  
 S-a considerat presiunea admisibila  $P=150$  Kpa

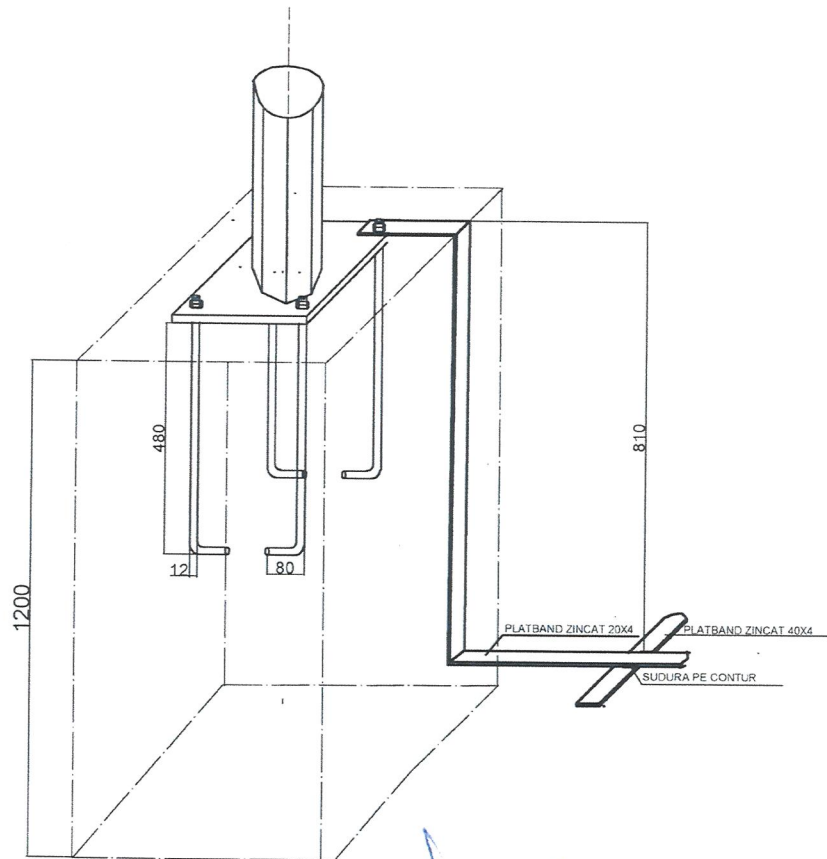
THE DOCUMENT/DRAWING IS INTELLECTUAL PROPERTY OF THE AUTHORS, TRANSMITTING OR COPYING, TOTALLY OR PARTIALLY, WITHOUT WRITTEN APPROVAL OF THE AUTHORS REPRESENT A BREAKING OF THE LAW NO 81/1996

 		PROEX INSTAL CONSULTING RO36670168;J51/504/2016 proexinstalconsulting@gmail.com		<b>-FUNDATIE STALP METALIC</b>		Plansa Nr. 7
ATESTAT Be;C1A		Nume	Semnatura	Scara:	Titlu Proiect: <b>Reducerea emisiilor de gaze cu efect de sera prin eficientizarea sistemului de iluminat public in comuna Gura Ocnitei</b>	faza PTh
SEF PROIECT	Ing Petrache Ion					
PROIECTANT	Ing Horia Cristescu			Data		
DESENAT	Ing Horia Cristescu			10.2023		



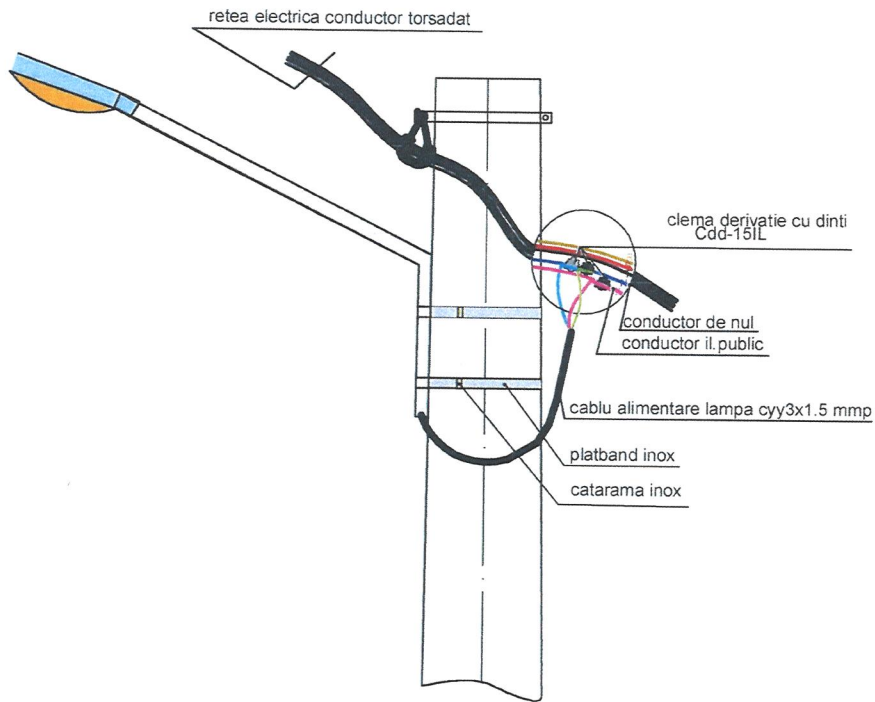

THE DOCUMENT/DRAWING IS INTELLECTUAL PROPERTY OF THE AUTHORS. TRANSMITTING OR COPYING, TOTALLY OR PARTIALLY, WITHOUT WRITTEN APPROVAL OF THE AUTHORS REPRESENT A BREAKING OF THE LAW/NOI 81/1998

 		PROEX INSTAL CONSULTING RO36670168; J51/504/2016 proexinstalconsulting@gmail.com		<i>detalii executie</i> <i>racord impantare</i> <i>stalp metalic de iluminat</i>		Plansa Nr.8	
ATESTAT Be;C1A							
	Nume	Semnatura	Scara:	Titlu Proiect: <b>Reducerea emisiilor de gaze cu efect de sera prin eficientizarea sistemului de iluminat public in comuna Gura Ocnitei</b>			
SEF PROIECT	Ing Petrache Ion						
PROIECTANT	Ing Dumbrava Virgil						
DESENAT	Ing Coman Cosmin		Data	10/2023			





THE DOCUMENT/DRAWING IS INTELLECTUAL PROPERTY OF THE AUTHORS. TRANSMITTING OR COPYING, TOTALLY OR PARTIALLY, WITHOUT WRITTEN APPROVAL OF THE AUTHORS REPRESENT A BREAKING OF THE LAW NO 8/1996

 		<b>PROEX INSTAL CONSULTING</b> RO36670168;J51/504/2016 proexinstalconsulting@gmail.com		<b>MONTAJ/RACORD CORP LAMPA          REȚEA CONDUCTOR IZOLAT</b>		Plansa Nr. 9
ATESTAT Be:C1A				Titlu Proiect:		FAZA PT
SEF PROIECT	Nume Ing Petrache Ion	Semnatura	Scara:	<b>Reducerea emisiilor de gaze cu efect de          sera prin eficientizarea sistemului de          iluminat public in comuna Gura          Ocnitei</b>		
PROIECTANT	Ing Dumbrava Virgil		Data			
DESENAT	Ing Coman Cosmin		10.2023			

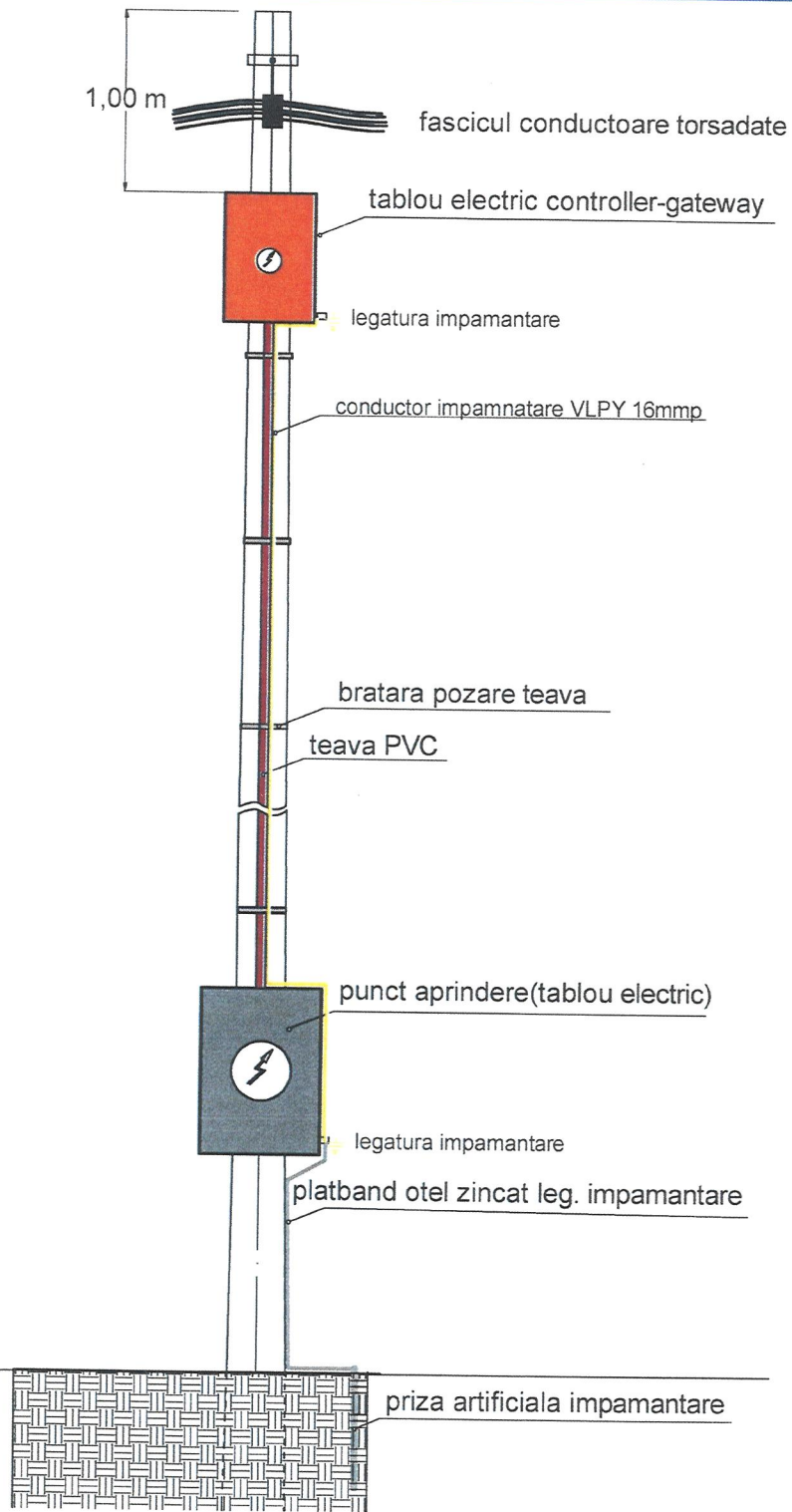

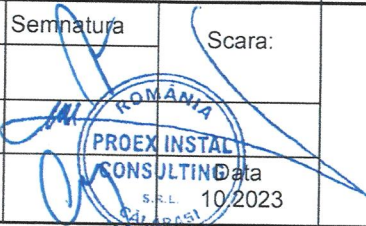

THE DOCUMENT/DRAWING IS INTELLECTUAL PROPERTY OF THE AUTHORS. TRANSMITTING OR COPYING, TOTALLY OR PARTIALLY, WITHOUT WRITTEN APPROVAL OF THE AUTHORS REPRESENT A BREACHING OF THE LAW NO 81/1996

 		<b>PROEX INSTAL CONSULTING</b> RO36670168; J51/504/2016 proexinstalconsulting@gmail.com		<b>MONTAJ tablou controller-concentrator</b>		Plansa Nr. 10	
ATESTAT Be: C1A							
	Nume	Semnatura	Scara:	Titlu Proiect: <b>Reducerea emisiilor de gaze cu efect de sera prin eficientizarea sistemului de iluminat public in comuna Gura Oenitei</b>		faza	
SEF PROIECT	Ing Petrache Ion					PT	
PROIECTANT	Ing Dumbrava Virgil						
DESENAT	Ing Coman Cosmin						
							

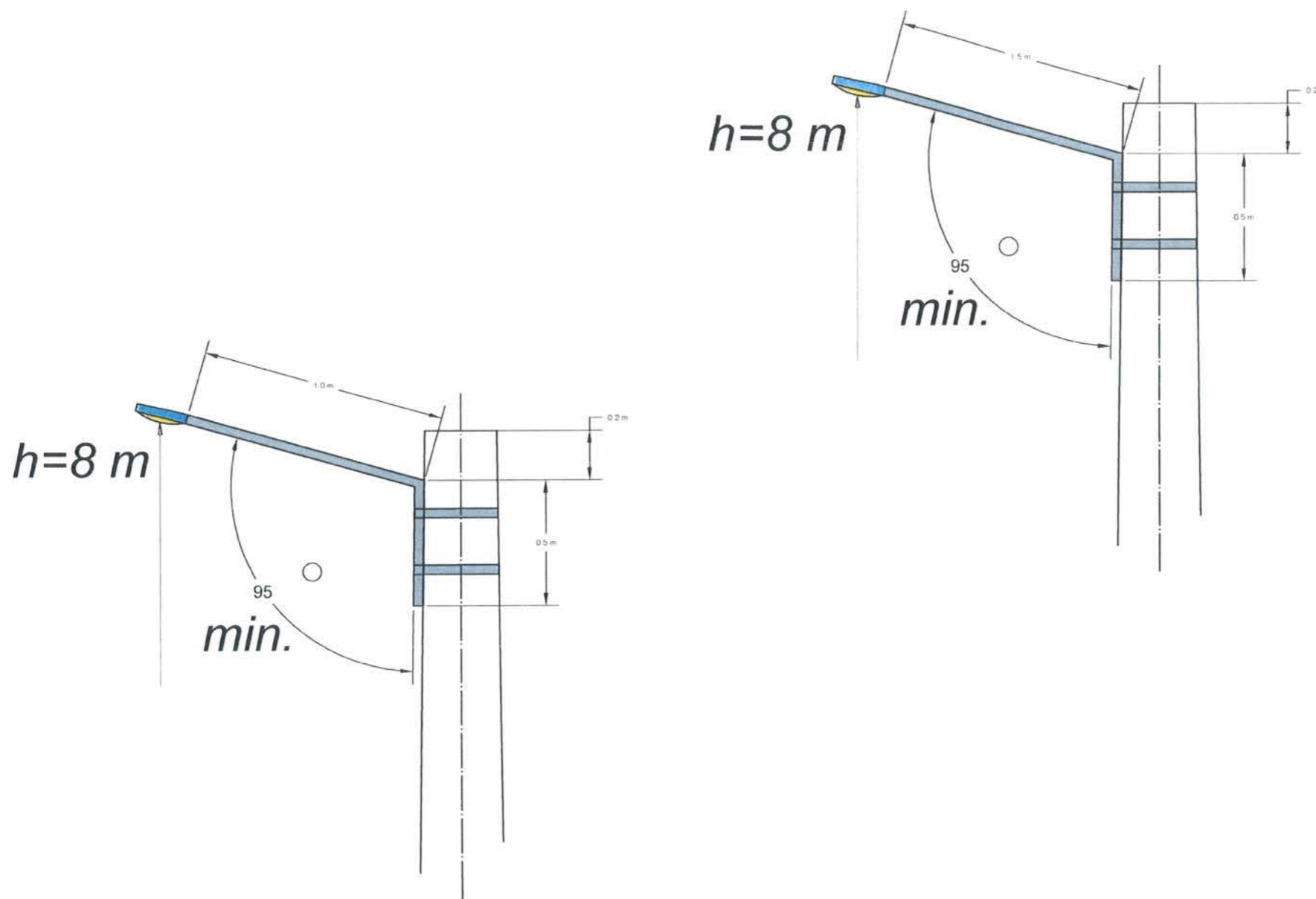

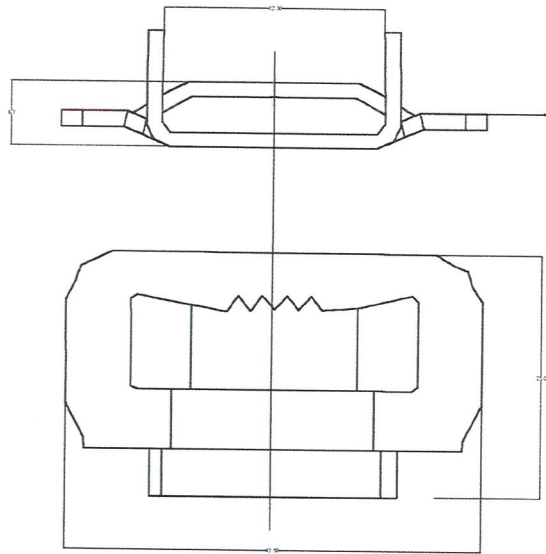

THE DOCUMENT/DRAWING IS INTELLECTUAL PROPERTY OF THE AUTHORS. TRANSMITTING OR COPYING, TOTALLY OR PARTIALLY, WITHOUT WRITTEN APPROVAL OF THE AUTHORS REPRESENT A BREAKING OF THE LAW NO 81/1996.

 		PROEX INSTAL CONSULTING RO36670168;J51/504/2016 proexinstalconsulting@gmail.com		<b>SUPPORT PRINDERE CONSOLA</b>		Plansa Nr. <b>11</b>
ATESTAT Be,C1A		Nume ing Petrace Ion	Semnatura 	Scara:	Titlu Proiect: <b>Reducerea emisiilor de gaze cu efect de sera prin eficientizarea sistemului de iluminat public in comuna Gura Oenitei</b>	
SEF PROIECT	PROIECTANT ing Dumbrava Virgil	DESENAT ing Coman Cosmin		Data 10.2023	faza PT	



THE DOCUMENT/DRAWING IS INTELLECTUAL PROPERTY OF THE AUTHORS. TRANSMITTING OR COPYING, TOTALLY OR PARTIALLY, WITHOUT WRITTEN APPROVAL OF THE AUTHORS REPRESENT A BREAKING OF THE LAW NO. 9/1996

 		<b>PROEX INSTAL CONSULTING</b> RO36670168;J51/504/2016 proexinstalconsulting@gmail.com		<i>catarama de inox prindere banda</i>		Plansa Nr.12	
ATESTAT Be:C1A							
	Nume	Semnatura	Scara:	Titlu Proiect:		faza	
SEF PROIECT	Ing Petrache Ion			<b>Reducerea emisiilor de gaze cu efect de sera prin eficientizarea sistemului de iluminat public in comuna Gura Ocnitei</b>		PT	
PROIECTANT	Ing Dumbrava Virgil						
DESENAT	Ing Coman Cosmin						



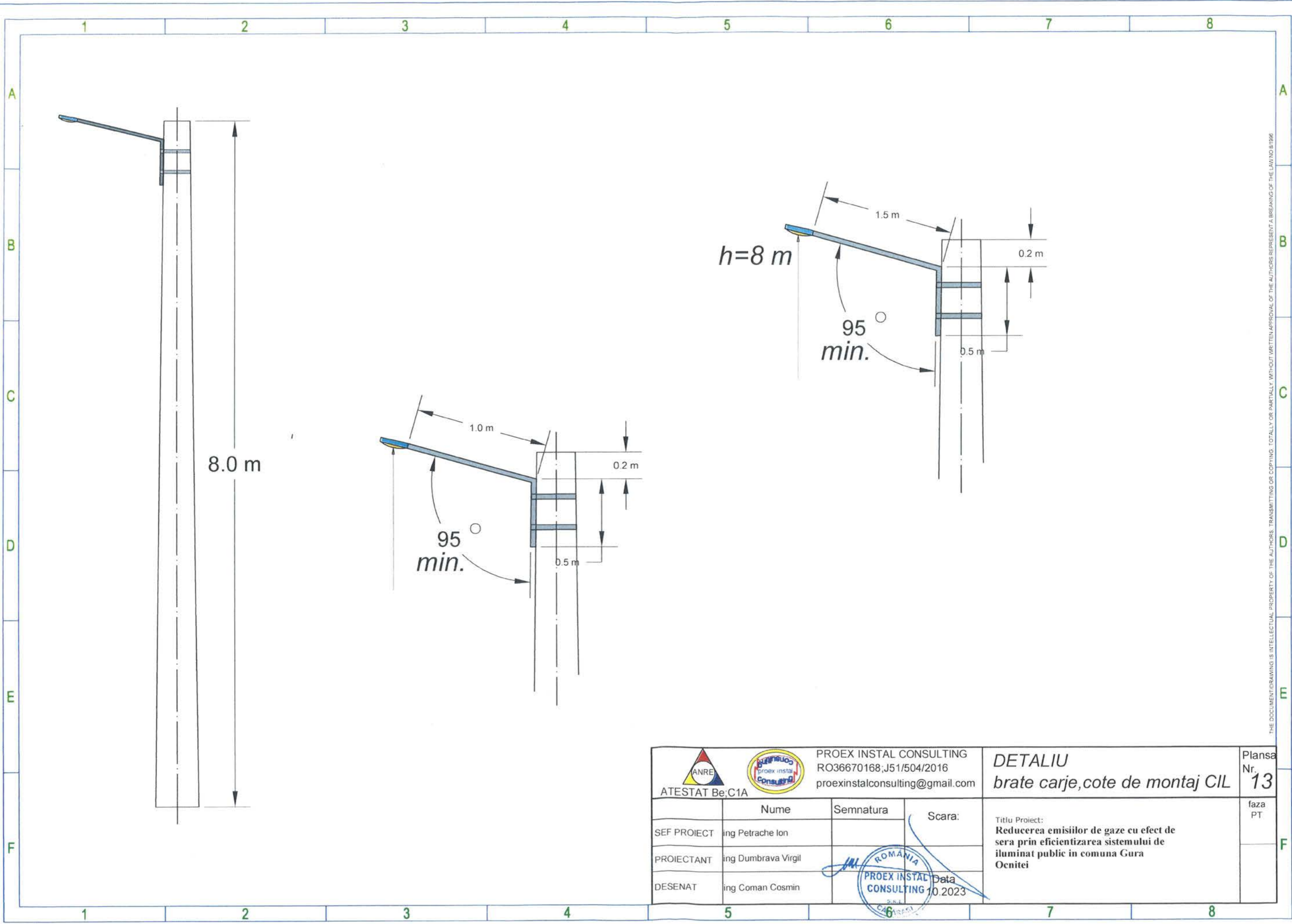

THE DOCUMENT/DRAWING IS INTELLECTUAL PROPERTY OF THE AUTHORS. TRANSMITTING OR COPYING, TOTALLY OR PARTIALLY, WITHOUT WRITTEN APPROVAL OF THE AUTHORS REPRESENT A BREAKING OF THE LAW NO. 8/1996

 		PROEX INSTAL CONSULTING RO36670168;J51/504/2016 proexinstalconsulting@gmail.com		<b>DETALIU</b> <i>brate carje, cote de montaj CIL</i>		Plansa Nr. <b>13</b>
ATESTAT Be;C1A		Scara:		Titlu Proiect: <b>Reducerea emisiilor de gaze cu efect de sera prin eficientizarea sistemului de iluminat public in comuna Gura Ocniței</b>		faza PT
SEF PROIECT	ing Petrache Ion	Semnatura				
PROIECTANT	ing Dumbrava Virgil					
DESENAT	ing Coman Cosmin					

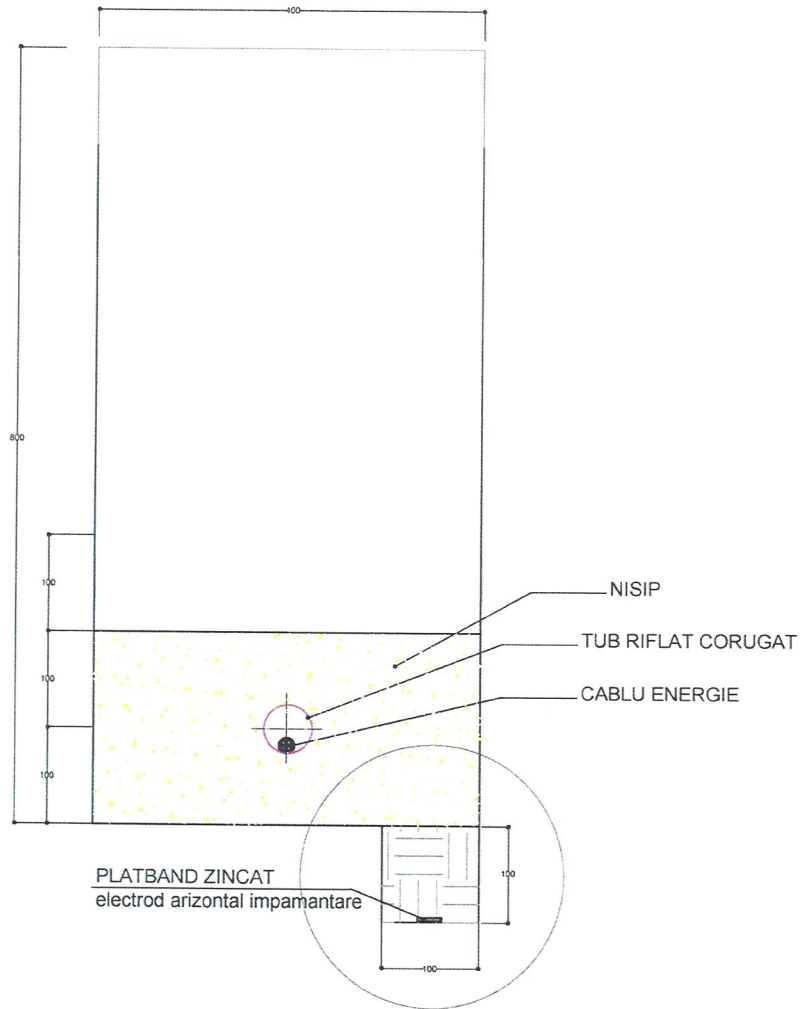



THE DOCUMENT/DRAWING IS INTELLECTUAL PROPERTY OF THE AUTHORS. TRANSMITTING OR COPYING, TOTALLY OR PARTIALLY, WITHOUT WRITTEN APPROVAL OF THE AUTHORS REPRESENT A BREAKING OF THE LAW NO. 8/1996

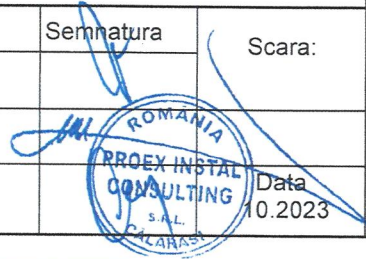

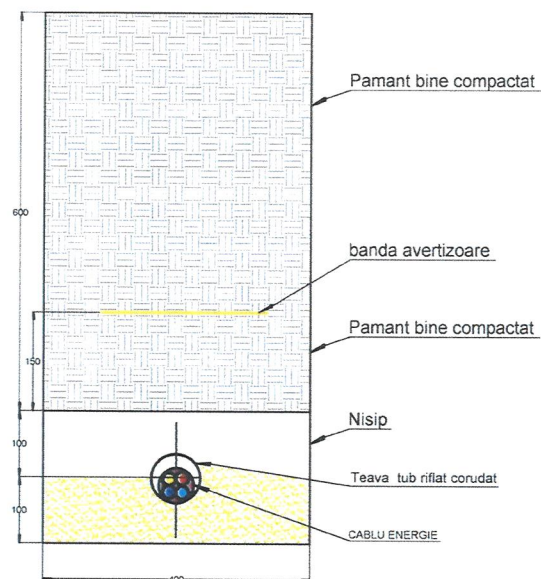
 		PROEX INSTAL CONSULTING RO36670168;J51/504/2016 proexinstalconsulting@gmail.com		<b>detalii executie</b> <b>POZARE PLATBAND IMPAMANTARE</b> <b>in sant comun cu LES,</b>		Plansa Nr. 14
ATESTAT Be;C1A		Scara:		Titlu Proiect: <b>Reducerea emisiilor de gaze cu efect de sera prin eficientizarea sistemului de iluminat public in comuna Gura Ocnitei</b>		faza PT
SEF PROIECT	Nume Ing Petrache Ion	Semnatura				
PROIECTANT	Ing Dumbrava Virgil					
DESESTAT	Ing Coman Cosmin		Data 10.2023			



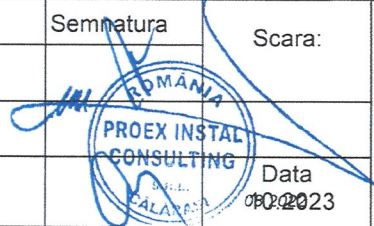

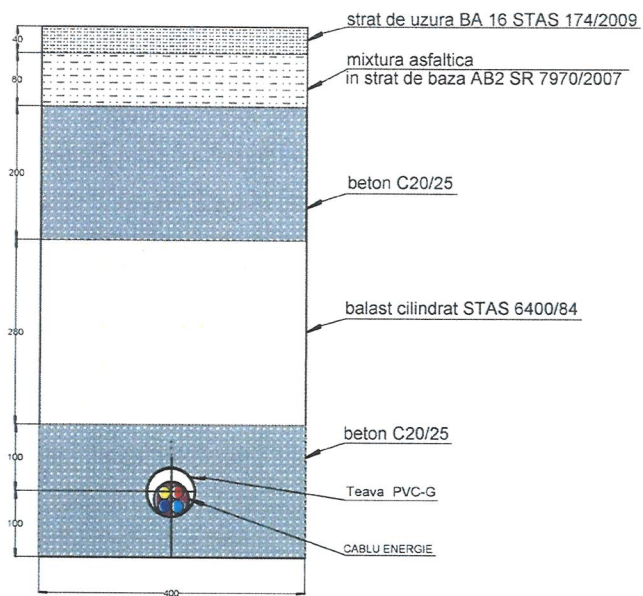
 		PROEX INSTAL CONSULTING RO36670168;J51/504/2016 proexinstalconsulting@gmail.com		<b>detalii executie PROFIL "M"</b>		Plansa Nr. 15
ATESTAT Be;C1A		Scara:		Titlu Proiect: <b>Reducerea emisiilor de gaze cu efect de sera prin eficientizarea sistemului de iluminat public in comuna Gura Ocnitei</b>		faza PT
SEF PROIECT	Ing Petrache Ion	Semnatura				
PROIECTANT	Ing Dumbrava Virgil					
DESENAT	Ing Coman Cosmin					Data



 		PROEX INSTAL CONSULTING RO36670168;J51/504/2016 proexinstalconsulting@gmail.com		<b>detalii executie</b> <b>PROFIL "T"</b>		Plansa Nr. <b>16</b>	
ATESTAT Be;C1A		Scara:		Titlu Proiect: <b>Reducerea emisiilor de gaze cu efect de sera prin eficientizarea sistemului de iluminat public in comuna Gura Ocnitei</b>		faza PT	
SEF PROIECT	Ing Petrache Ion	Semnatura					
PROIECTANT	Ing Dumbrava Virgil						
DESENAT	Ing Coman Cosmin					Data	10.2023