

expert teh. verificator	cerinta	expertiza nr.	PR.NR. 34/2022
	cerinta	referat nr.	
SEF PROIECT PROIECTAT DESENAT	Ing. Nicolai Petrisor Arh. Florical Irina Ing. Bobiti Patricia	DAVIDE EL BRAVO SRL Drobeta Turnu Severin B-dul. Mihai Viteazul, nr. 2C J25179/2013, CUI: R031700497	Beneficiar: MUNICIPIUL DROBETA TURNU SEVERIN Titlu proiect: Reabilitare gradinita cu PP nr. 22 din municipiul Drobeta Turnu Severin
		\$CATA 1:100000	
		data 2022	

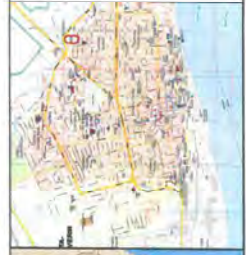

Zona amplasament lucrari















# FAȚADĂ NORD

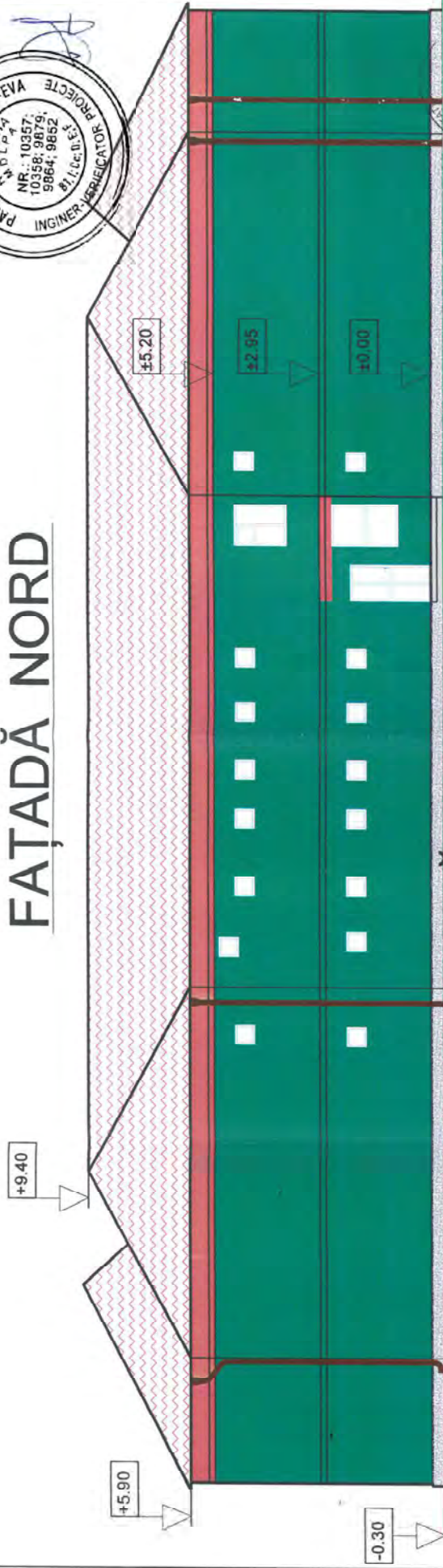

# FAȚADĂ SUD

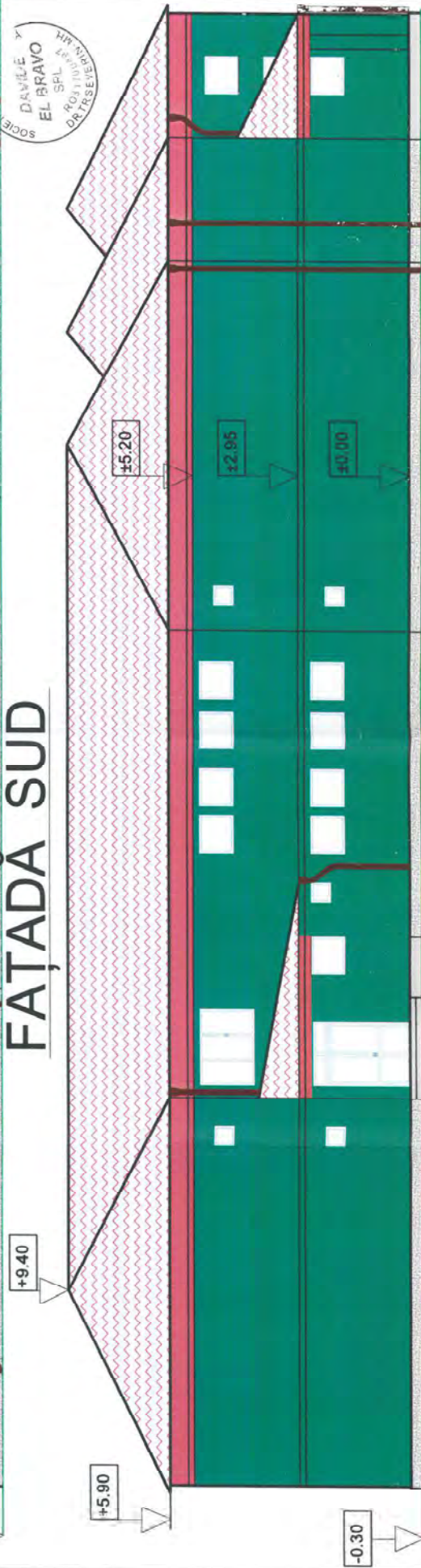

expert teh. verificator	cerinta cerinta	expertiza nr. referat nr.
SEF PROIECT Ing. Nicolai Petrisor	Beneficiar: U.A.T. - DROBETA TURNU SEVERIN	pr. nr. 34/2022
PROIECTAT Arh. Floricel Irina	Reabilitare gradinita cu PP nr.22 din municipiul Drobeta Turnu Severin	faza D.A.L.I.
DESENAT Ing. Bobiti Patricia	Scara 1:100 data 2022	planșa A/08

ING. ELEONORA-EVA  
10357  
10358  
9879  
9864  
9852



FATADĂ VEST

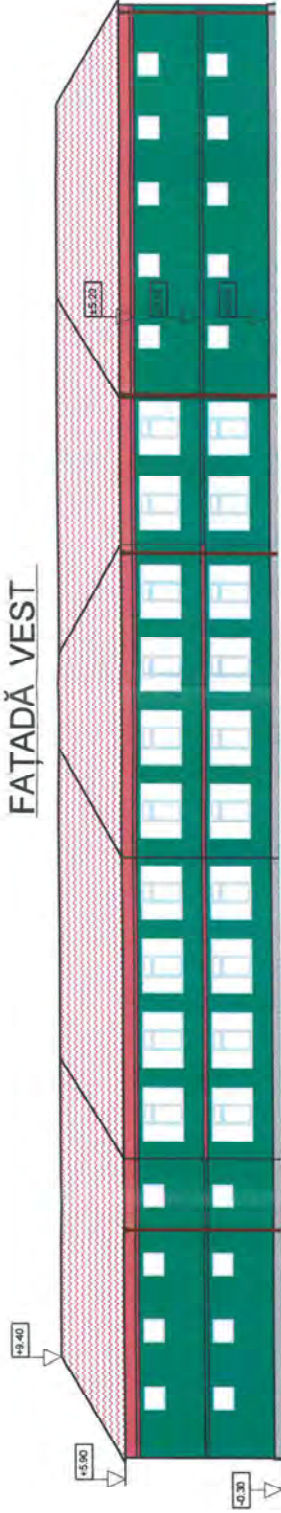

FATADĂ EST

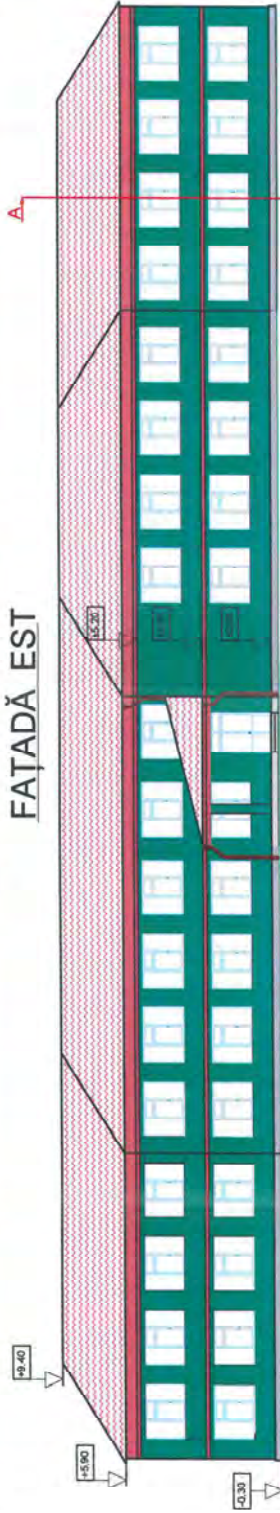

expert teh. verificator	cerinta cerinta	expertiza nr. referat nr.
SEF PROIECT	<b>DAVIDE EL BRAVO SRL</b> Drobeta Turnu Severin	Beneficiar: U.A.T. - DROBETA TURNU SEVERIN
PROIECTAT	Drobeta Turnu Severin, nr. 2C Bulevardul Mihai Viteazul, nr. 2C J25/179/2013, CUI: RO31700497	Reabilitare gradinita cu PP nr 22 din municipiul Drobeta Turnu Severin
DESENAT	Ing. Nicolai Petrisor An. Floricel Irina Ing. Bobiti Patricia	Plan fatada Vest si fatada Est-Situatie existenta
	Scara 1:50 data 2022	pr. nr. 34/2022 faza D.A.L.I. plansa A09











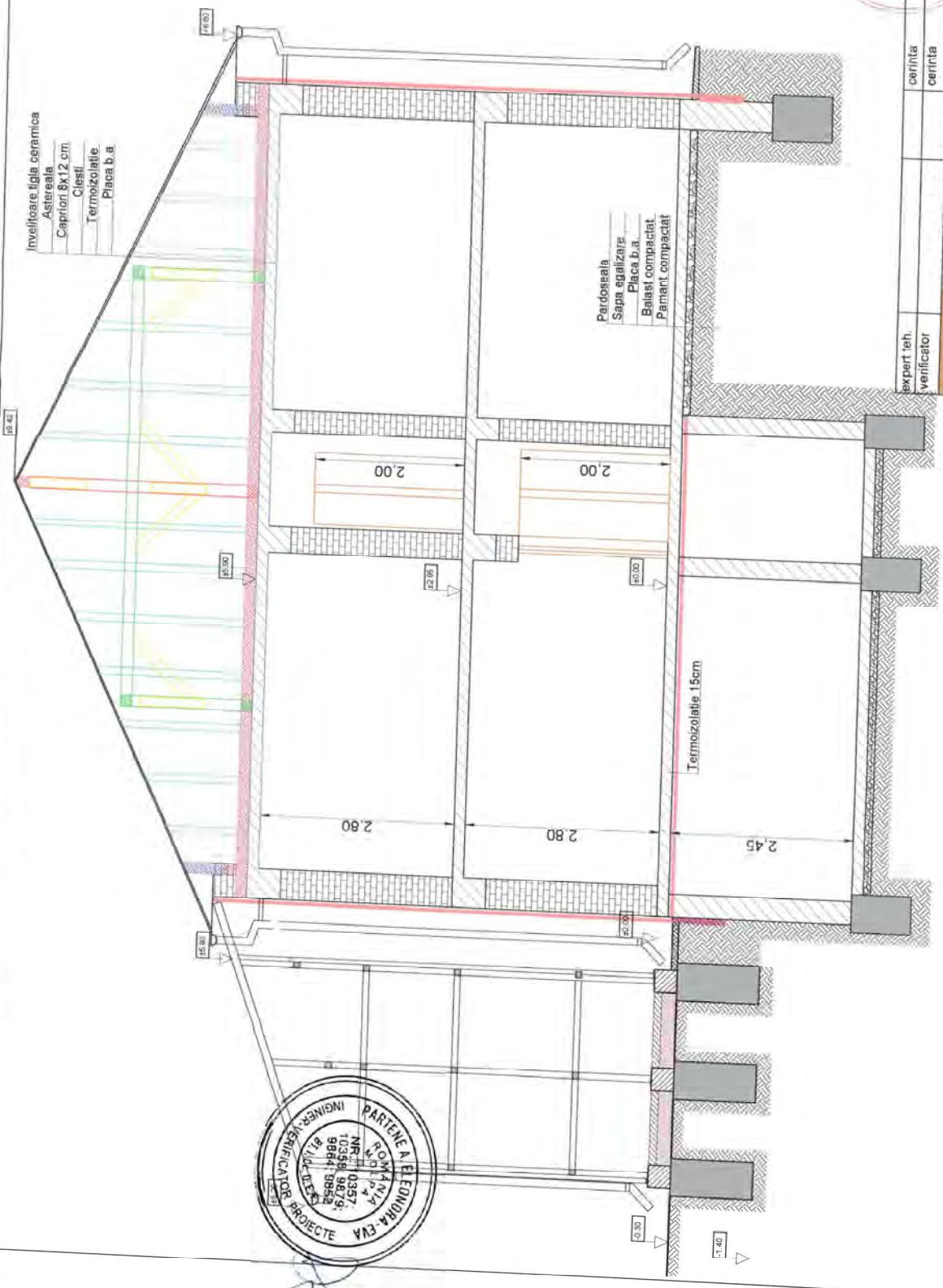

expert teh. verificator	centina	expertiza nr.	pr.nr.
DAVIDE EL BRAVO SRL	centina	relebrat nr.	34/2022
Drobeta Turnu Severin Bulevardul Mihai Viteazul, nr. 2C J25-179/2013, CUI: RO31700497	Beneficiar	U.A.T. - DROBETA TURNU SEVERIN	faza
SEF PROIECT ing. Nicolai Petrisor	Realizator	Restabilire gradinita cu pp nr. 22 din municipiul Drobeta Turnu Severin	D.A.L.I.
PROIECTAT Arh. Florinel Iltina	scara		planșa
REZEMAT Ing. D. L. D. P. P. P.	data	1.50	A15
			Plan secțiune B-B Cămină școlară

# FAȚADĂ NORD

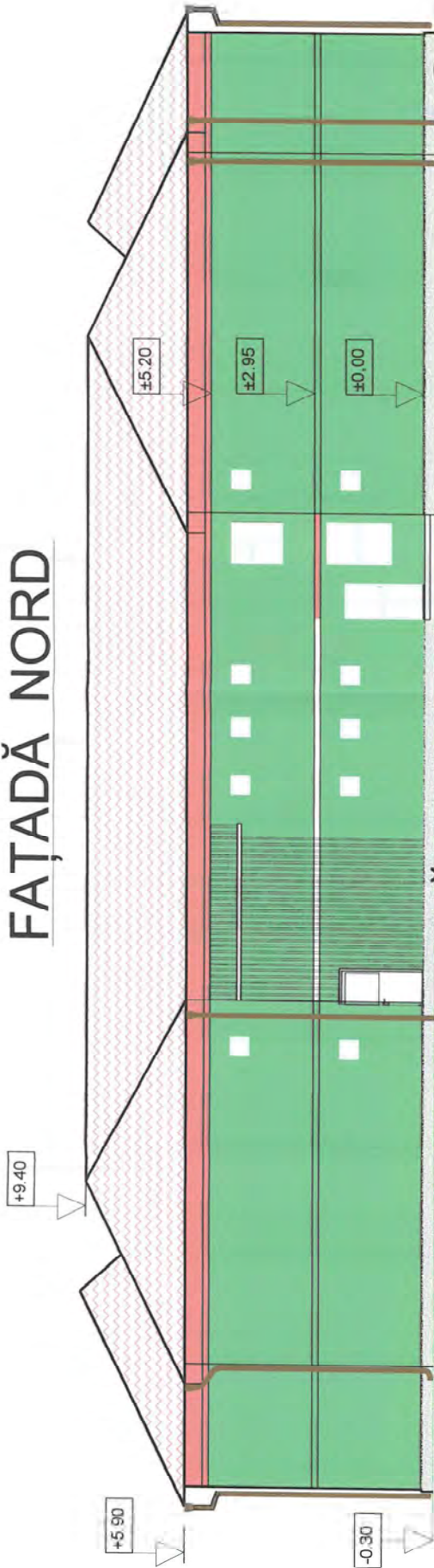

# FAȚADĂ SUD

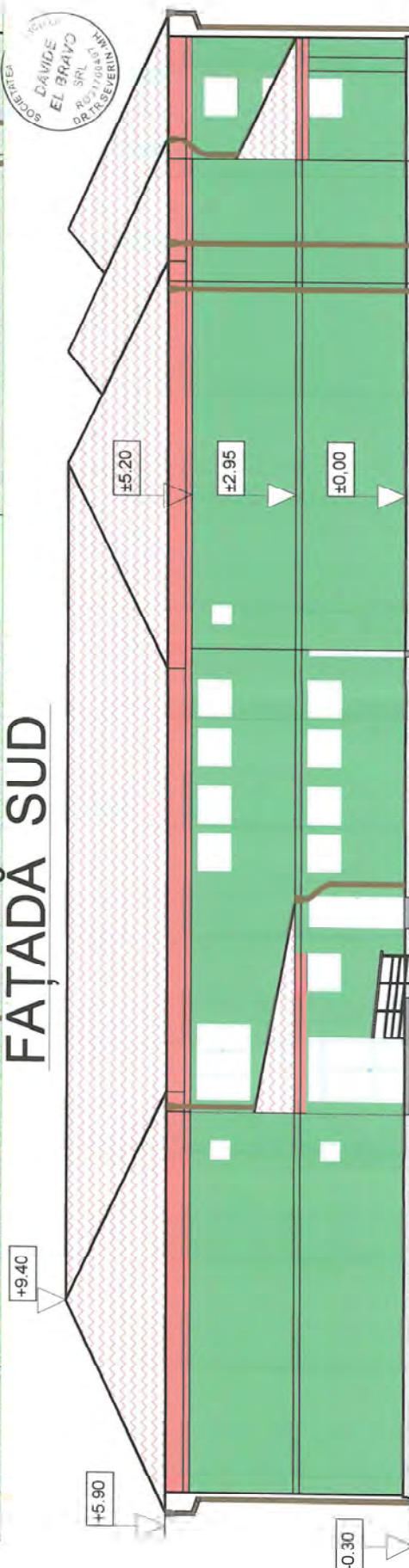

SOCIETATE  
**DAVIDE  
 EL BRAVO**  
 SRL  
 RO 25179/2013  
 HWININ  
 DR.TURSEVERIN

expert teh. verificator	DAVIDE EL BRAVO SRL Drobeta Turnu Severin Bulevardul Mihai Viteazul, nr. 2C J25/179/2013, CUI: RO31700497	centinta	centinta	experitiza nr. referat nr.
PROIECTAT DESENAT	Ing. Nicolai Petrisor Aih. Floricel Irima Ing. Bobiti Patricia	scara 1:100	data 2022	
SEF PROIECT	Ing. Nicolai Petrisor	Beneficiar: U.A.T. - DROBETA TURNU SEVERIN		
		Reabilitare gradinite cu PP nr. 22 din municipiul Drobeta Turnu Severin		
		faza D.A.L.I.		
		Plan fatada Nord si fatada Sud- Situatie propusa		
		planşa A16		



# FAȚADĂ NORD

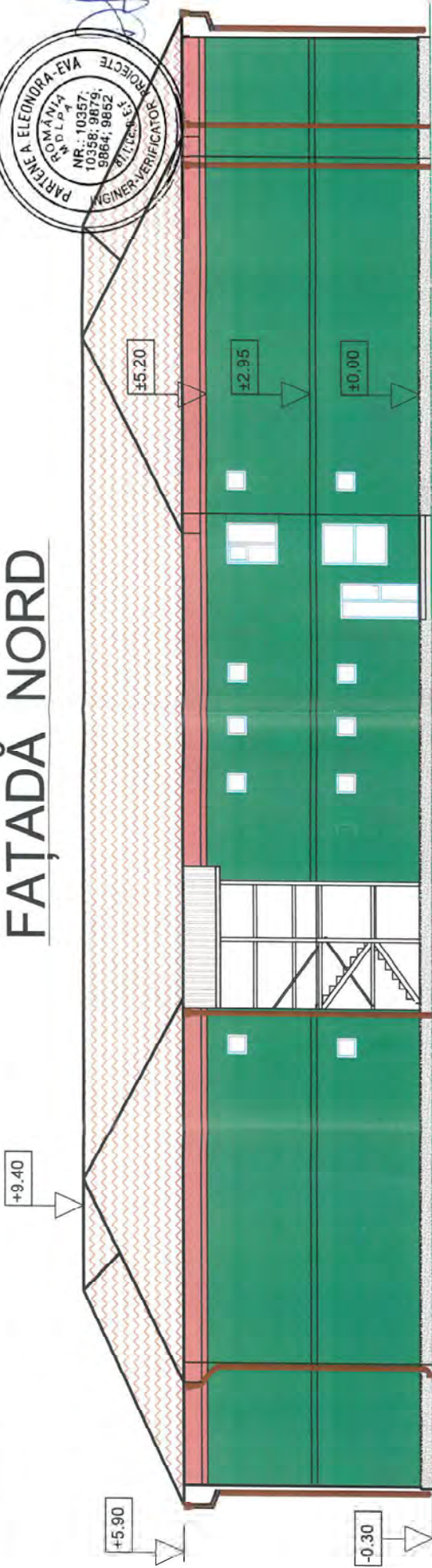

# FAȚADĂ SUD

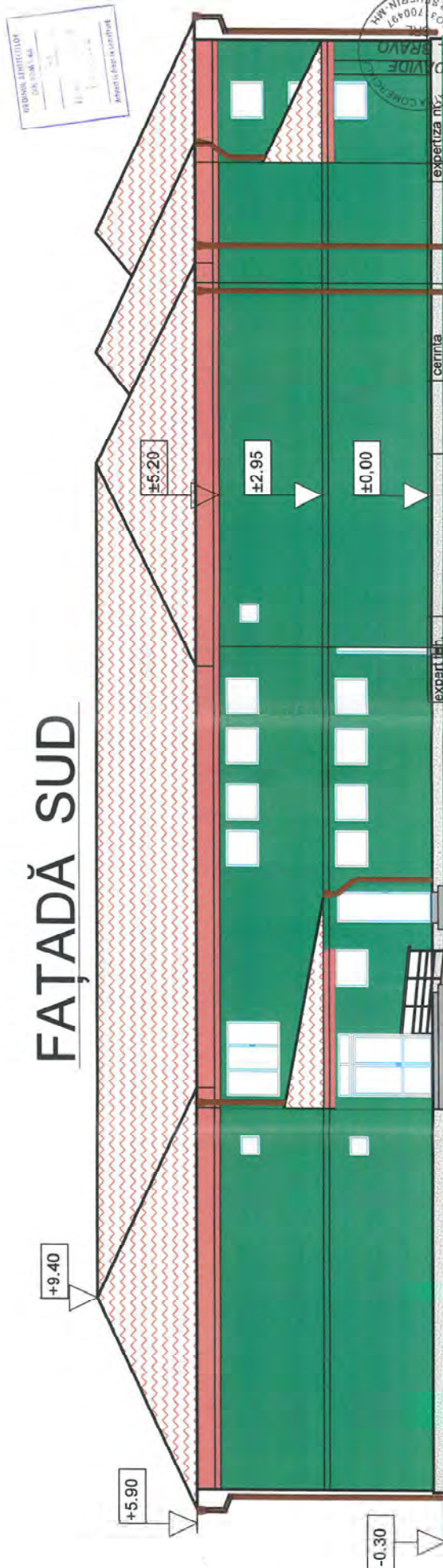

**Legenda:**

- 1 - Invelitoare din tigla;
- 2 - Tencuiele exterioare verde;
- 4 - Tamplarie eficiente energetice;
- 5 - Tencuiele exterioare - soclu;
- 6 - Igheaburi si burlane din Tabla zincata, natur.
- 7 - Scara de incendiu exterioara

**DAVIDE EL BRAVOSRL**  
Drobeta Turnu Severin  
Bulevardul Mihai Viteazul, nr. 2C  
J25/179/2013, CUI: RO31700497

SEF PROIECT Ing. Nicolai Petrisor  
PROIECTAT Arh. Floricel Irina  
DESEINAT Ing. Bobiti Patricia

scara  
1:100  
data  
2022

Beneficiar: U.A.T. - DROBETA TURNU SEVERIN  
Reabilitare gradinita cu PP nr.22 din municipiul Drobeta Turnu Severin

pr.nr 34/2022  
faza D.A.L.I.  
planșa A.15

expertiza nr. referat nr.  
cerinta cerinta



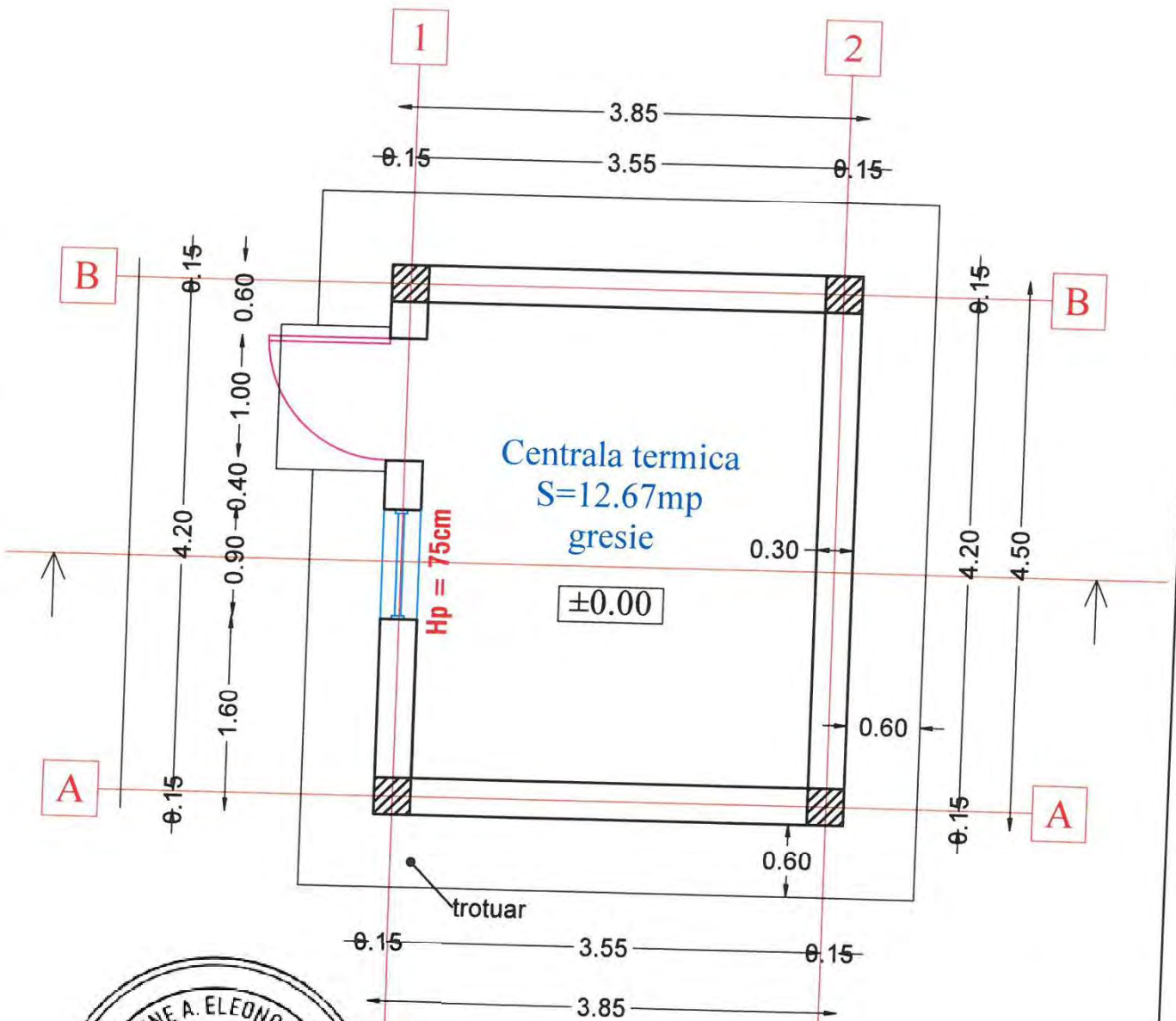

expert teh. verificator		cerinta	expertiza nr.
		cerinta	referat nr.
 <b>DAVIDE EL BRAVO SRL</b> Drobeta Turnu Severin Bulevardul Mihai Viteazul, nr. 2C J25/179/2013, CUI: RO31700497		Beneficiar: U.A.T. - DROBETA TURNU SEVERIN Reabilitare gradinita cu PP nr.22 din municipiul Drobeta Turnu Severin	
SEF PROIECT	Ing. Nicoli Petrisor	scara	pr.nr.
PROIECTAT	Arh. Floricel Irina	1:50	34/2022
DESENAT	Ing. Bobiti Patricia	data	faza
		2022	D.A.L.I.
Plan centrala termica			plansa
			A18

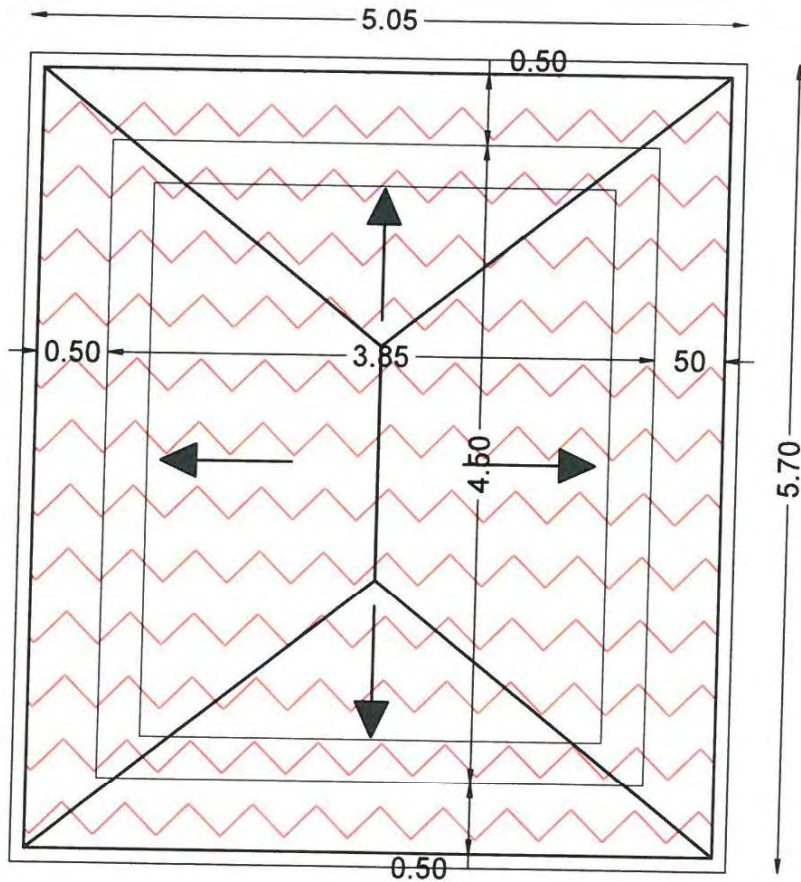

expert teh.		cerinta	expertiza nr.
verificator		cerinta	referat nr.
 <b>DAVDE EL BRAVO SRL</b> Drobeta Turnu Severin Bulevardul Mihai Viteazul, nr. 2C J25/179/2013, CUI: RO31700497		Beneficiar: U.A.T. - DROBETA TURNU SEVERIN Reabilitare gradinita cu PP nr.22 din municipiul Drobeta Turnu Severin	
SEF PROIECT	Ing. Nicoli Petrisor	scara 1:50 data 2022	Plan invelitoare centrala termica
PROIECTAT	Arh. Floricel Irina		
DESENAT	Ing. Bobiti Patricia		
			pr.nr. 34/2022 faza D.A.L.I. plansa A19

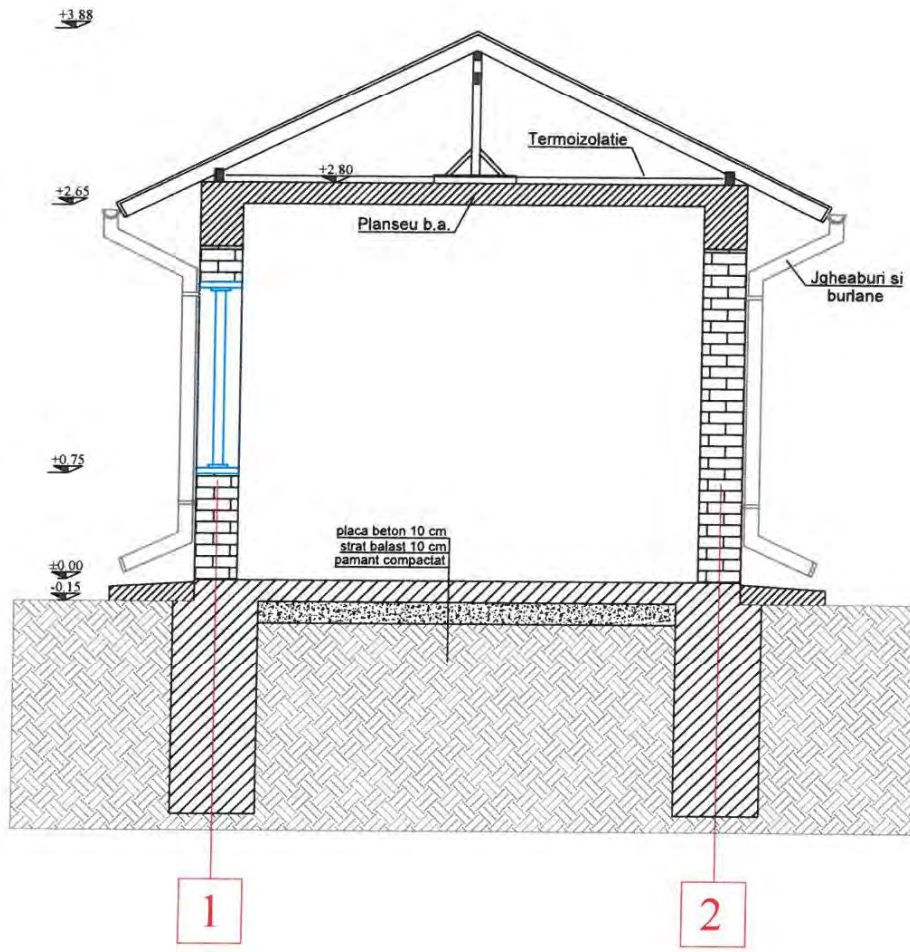

expert teh.		cerinta	expertiza nr.
verificator		cerinta	referat nr.
 <b>DAVIDE EL BRAVO SRL</b> Drobeta Turnu Severin Bulevardul Mihai Viteazul, nr. 2C J25/179/2013, CUI: RO31700497		Beneficiar: U.A.T. - DROBETA TURNU SEVERIN	
		Reabilitare gradinita cu PP nr.22 din municipiul Drobeta Turnu Severin	
SEF PROIECT	Ing. Nicolai Petrisor	scara 1:50	Plan sectiune centrala termica
PROIECTAT	Arh. Floricel Irina		
DESENAT	Ing. Bobiti Patricia	data 2022	pr.nr. 34/2022 faza D.A.L.I. plansa A20

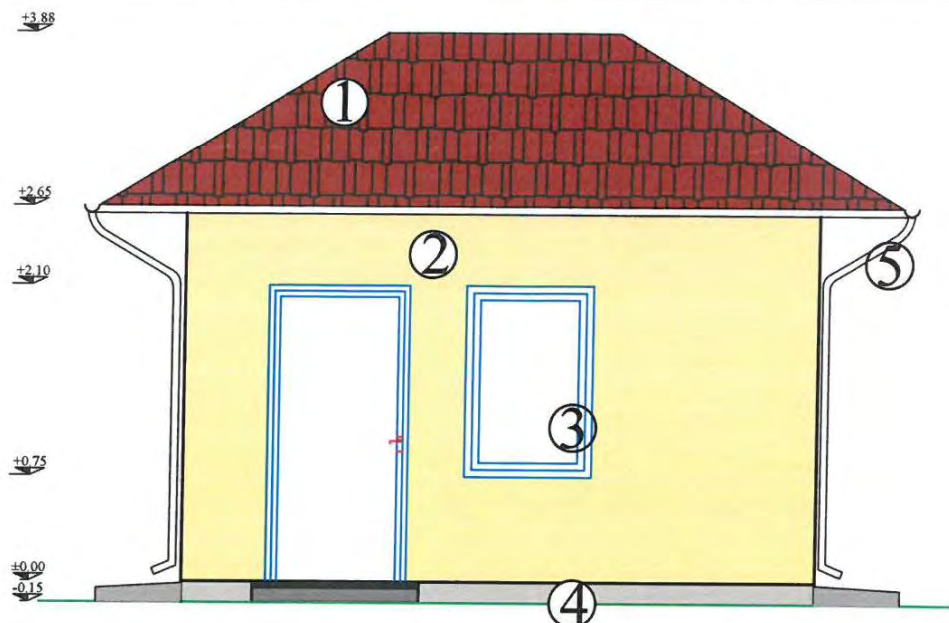

Legenda:

- 1 - Invelitoare din tigla metalica profilata;
- 2 - Tencuieli decorative tip Baumit;
- 3 - Tamplarie aluminiu
- 4 - Soclu - Tencuieli decorative tip Mozaic;
- 5 - Jgheaburi si burlane din otel vopsit electrostatic;

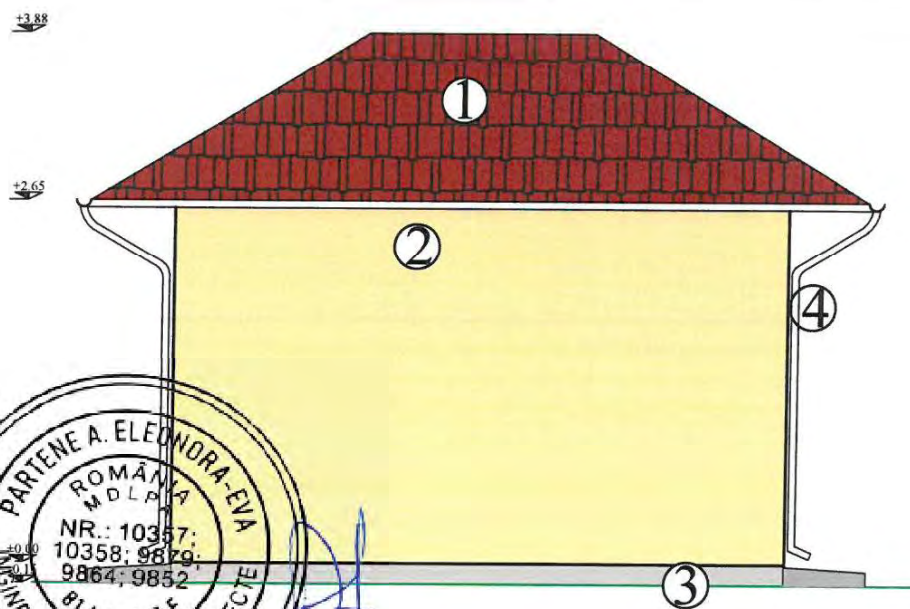

ORDINUL ARHITECTILOR  
DIN ROMANIA  
00045  
Irina Floricel  
FLORICEL  
Arhitect cu drept de semnătură



expert teh verificator		cerinta	expertiza nr.
		cerinta	referat nr.
 <b>DAVIDE EL BRAVO SRL</b> Drobeta Turnu Severin Bulevardul Mihai Viteazul, nr. 2C J25/179/2013, CUI: RO31700497		Beneficiar: U.A.T. - DROBETA TURNU SEVERIN Reabilitare gradinita cu PP nr.22 din municipiul Drobeta Turnu Severin	
SEF PROIECT	Ing. Nicolai Petrisor	scara	pr.nr.
PROIECTAT	Arh. Floricel Irina	1:50	34/2022
DESENAT	Ing. Bobiti Patricia	data	faza
		2022	D.A.L.I.
<b>Fatade centrala termica</b>			plansa A21

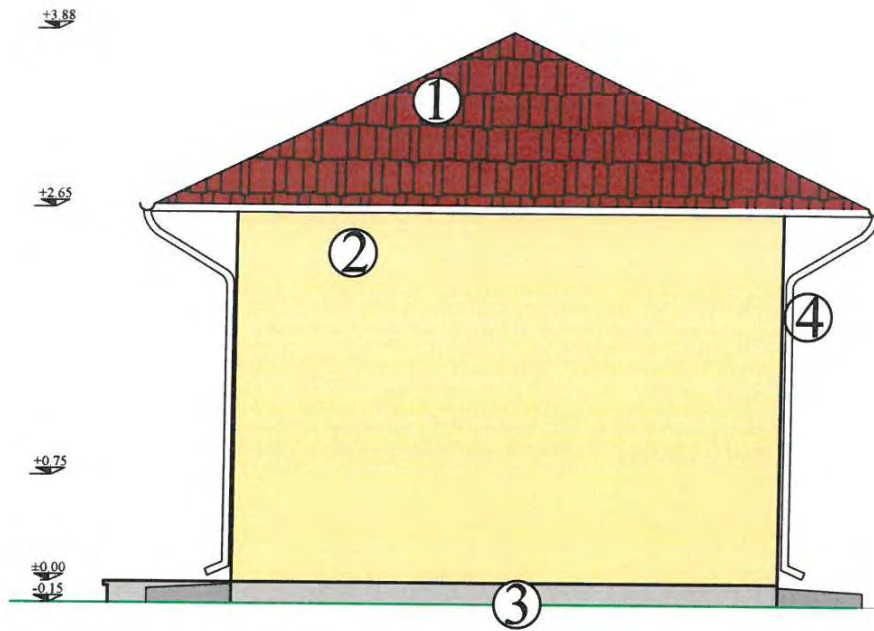

Legenda:

- 1 - Invelitoare din tigla metalica profilata;
- 2 - Tencuieli decorative tip Baumit;
- 3 - Soclu - Tencuieli decorative tip Mozaic;
- 4 - Jgheaburi si burlane din otel vopsit electrostatic;

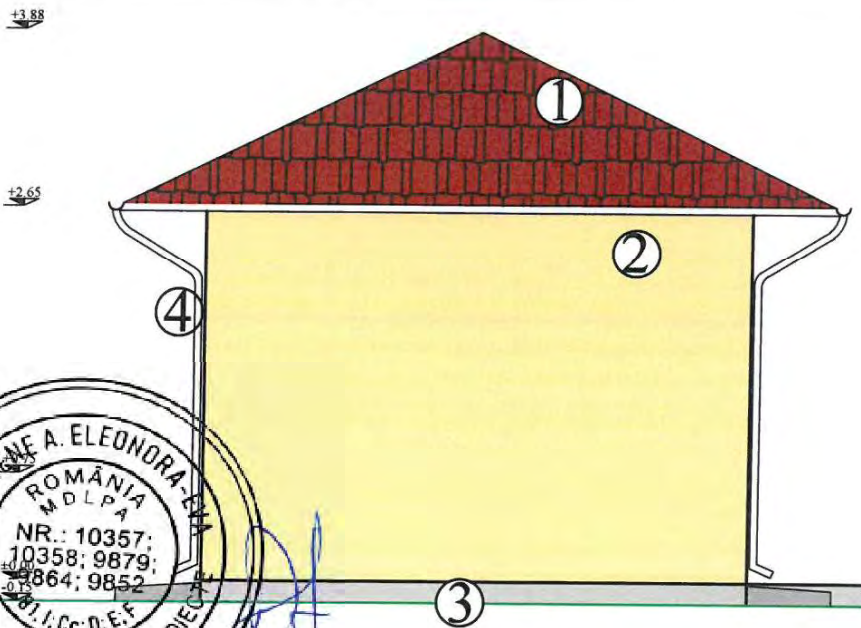

expert teh.		cerinta	expertiza nr.
verificator		cerinta	referat nr.
 <b>DAVIDE EL BRAVO SRL</b> Drobeta Turnu Severin Bulevardul Mihai Viteazul, nr. 2C J25/179/2013, CUI: RO31700497		Beneficiar: U.A.T. - DROBETA TURNU SEVERIN Reabilitare gradinita cu PP nr.22 din municipiul Drobeta Turnu Severin	
SEF PROIECT	Ing. Nicoli Petrisor	scara 1:50 data 2022	Fatade centrala termica
PROIECTAT	Arh. Floricel Irina		
DESENAT	Ing. Bobiti Patricia		
			pr.nr. 34/2022 faza D.A.L.I. plansa A22

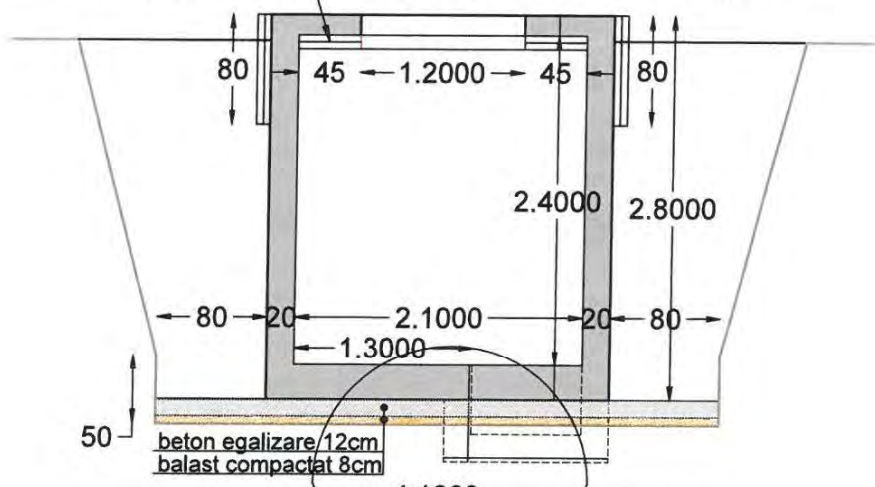
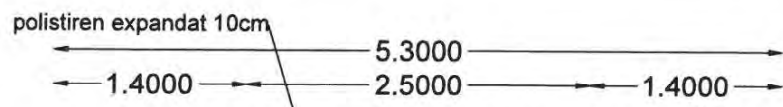
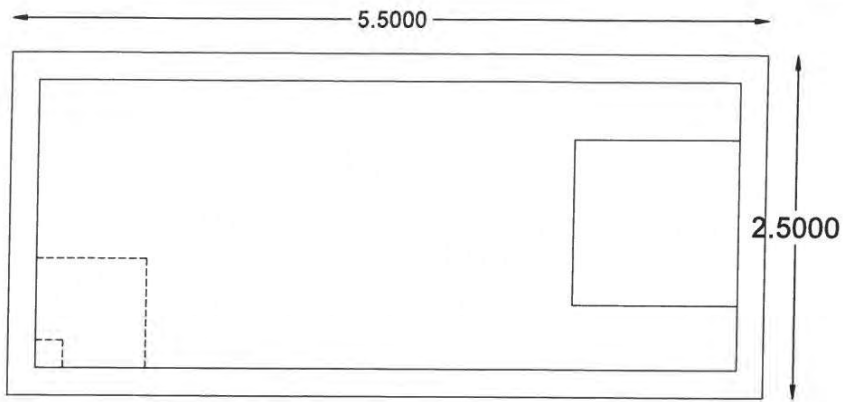

ORDINUL ARHITECTILOR  
DIN ROMANIA  
00045  
Irina Eleonora  
FLORICEL  
Arhitect cu drept de semnătură

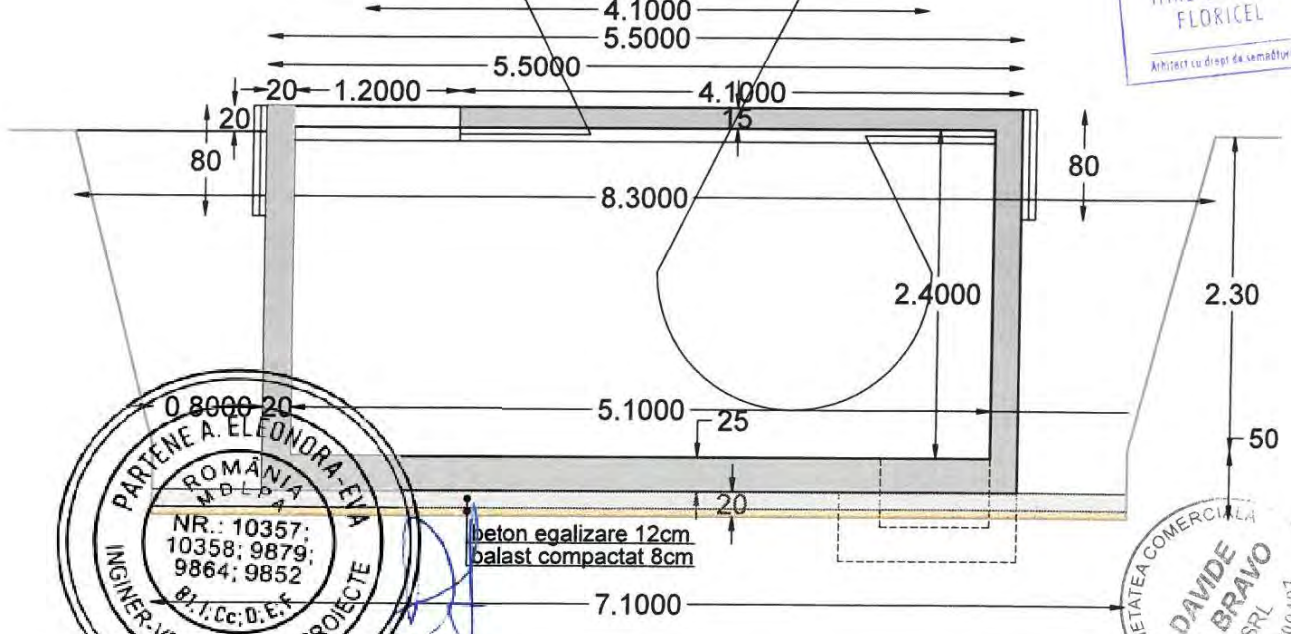

0.8000 20  
PARTENE A. ELEONORA-EVA  
ROMANIA  
MDLPA  
NR.: 10357;  
10358; 9879;  
9864; 9852  
S.I. Cc; D.E.F.  
INGINER-VERIFICATOR PROIECTE

SOCIETATEA COMERCIALA  
DAVIDE  
EL BRAVO  
SRL  
RO31700497  
22 TR SEVERIN-41H

expert teh.		cerinta	expertiza nr.
verificator		cerinta	referat nr.
 <b>DAVIDE EL BRAVO SRL</b> Drobeta Turnu Severin Bulevardul Mihai Viteazul, nr. 2C J25/179/2013, CUI: RO31700497		Beneficiar: U.A.T. - DROBETA TURNU SEVERIN Reabilitare gradinita cu PP nr.22 din municipiul Drobeta Turnu Severin	
SEF PROIECT	Ing. Nicolai Petrisor	scara	pr.nr.
PROIECTAT	Arh. Floricel Irina	1:50	34/2022
DESENAT	Ing. Bobiti Patricia	data	faza
		2022	D.A.L.I.
Plan statie de pompare			plansa
			A23







ACyAby 3x6

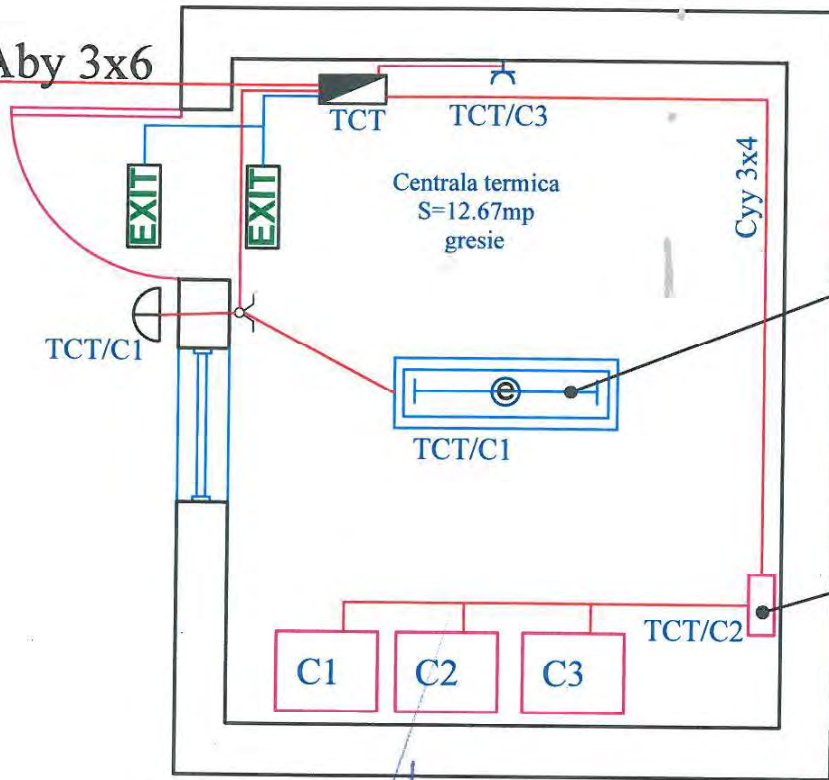

Corp iluminat cu kit emergenta 1h pentru interventii

Controler centrale termice



expert teh.		cerinta	expertiza nr.
verificator		cerinta	referat nr.
 <b>DAVIDE EL BRAVO SRL</b> Drobeta Turnu Severin Bulevardul Mihai Viteazul, nr. 2C J25/179/2013, CUI: RO31700497		Beneficiar: U.A.T. - DROBETA TURNU SEVERIN	
		Reabilitare gradinita cu PP nr.22 din municipiul Drobeta Turnu Severin	
SEF PROIECT	Ing. Nicoli Petrisor	scara 1:50	pr.nr. 34/2022
PROIECTAT	Ing. Nicoli Petrisor	data 2022	faza D.A.L.I.
DESENAT	Ing. Bobiti Patricia		plansa IE08















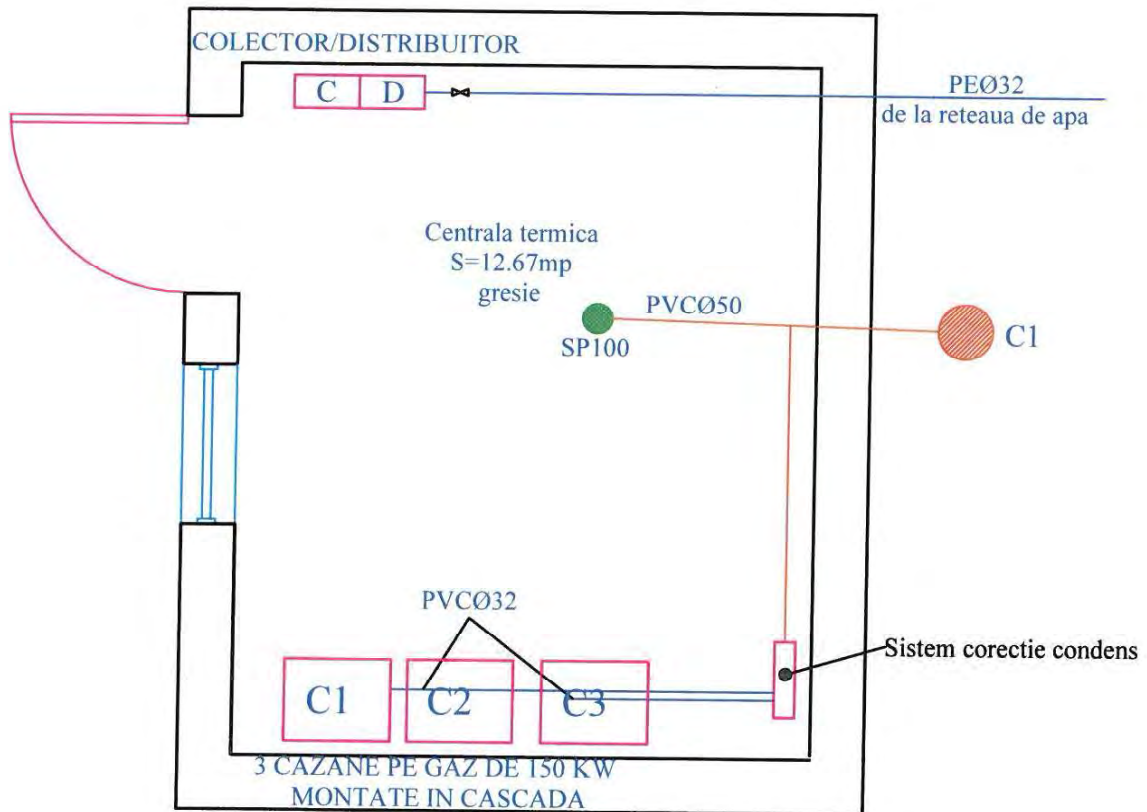

expert teh.		cerinta	expertiza nr.
verificator		cerinta	referat nr.
 <b>DAVIDE EL BRAVO SRL</b> Drobeta Turnu Severin Bulevardul Mihai Viteazul, nr. 2C J25/179/2013, CUI: RO31700497		Beneficiar: U.A.T. - DROBETA TURNU SEVERIN Reabilitare gradinita cu PP nr.22 din municipiul Drobeta Turnu Severin	
SEF PROIECT	Ing. Nicolii Petrisor	scara	pr.nr.
PROIECTAT	Ing. Nicolii Petrisor	1:50	34/2022
DESEMAT	Ing. Bobiti Patricia	data	faza
		2022	D.A.L.I.
Plan centrala termica Instalatii sanitare			plansa IS04

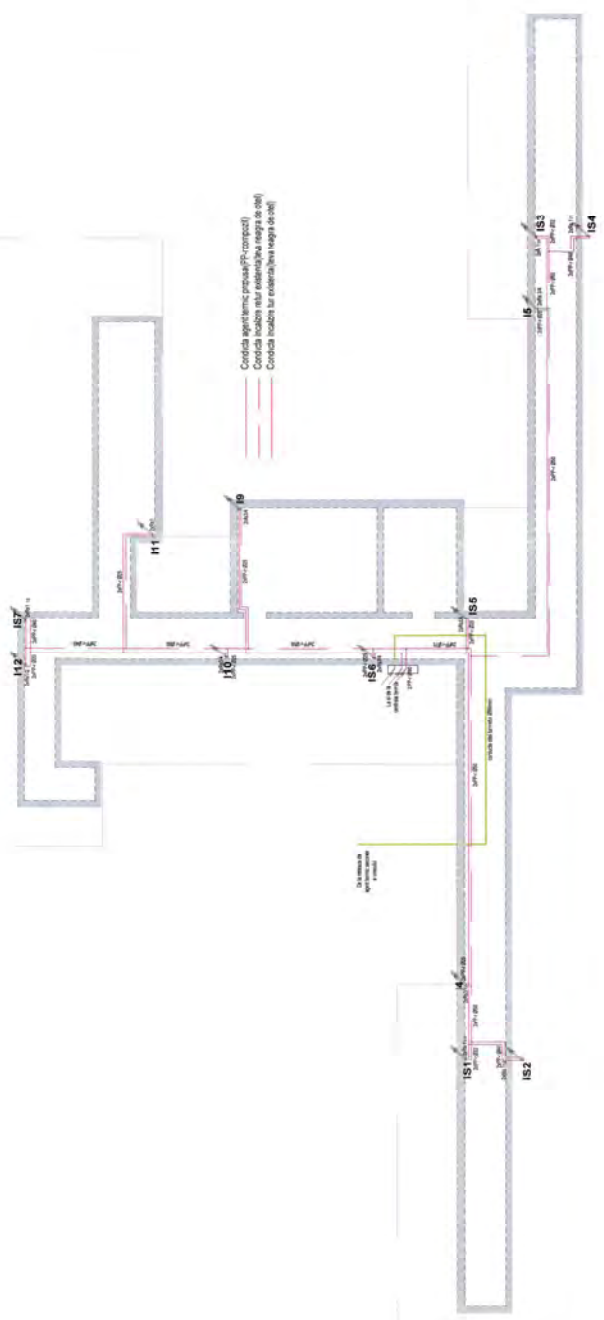

**CEPARG C. D.S.**  
 Căminarilor nr. 10  
 01044  
 București

PROIECTANT	ING. BOGDAN POPESCU	SCALA	1:100
PROIECTANT	ING. NICOLAE POPESCU	DATA	2022
PROIECTANT	ING. NICOLAE POPESCU	PROIECTANT	ING. BOGDAN POPESCU
PROIECTANT	ING. BOGDAN POPESCU	PROIECTANT	ING. BOGDAN POPESCU

**DANIEL BRANCOȘ**  
 Director Tehnic  
 București, Calea București nr. 2C  
 SC. 100  
 01044

**DRAGOMIR TURBULEA**  
 Director Tehnic  
 București, Calea București nr. 2C  
 SC. 100  
 01044

**DRAGOMIR TURBULEA**  
 Director Tehnic  
 București, Calea București nr. 2C  
 SC. 100  
 01044

**DRAGOMIR TURBULEA**  
 Director Tehnic  
 București, Calea București nr. 2C  
 SC. 100  
 01044





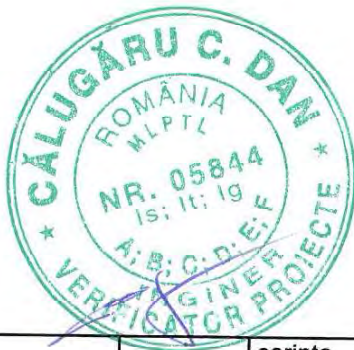
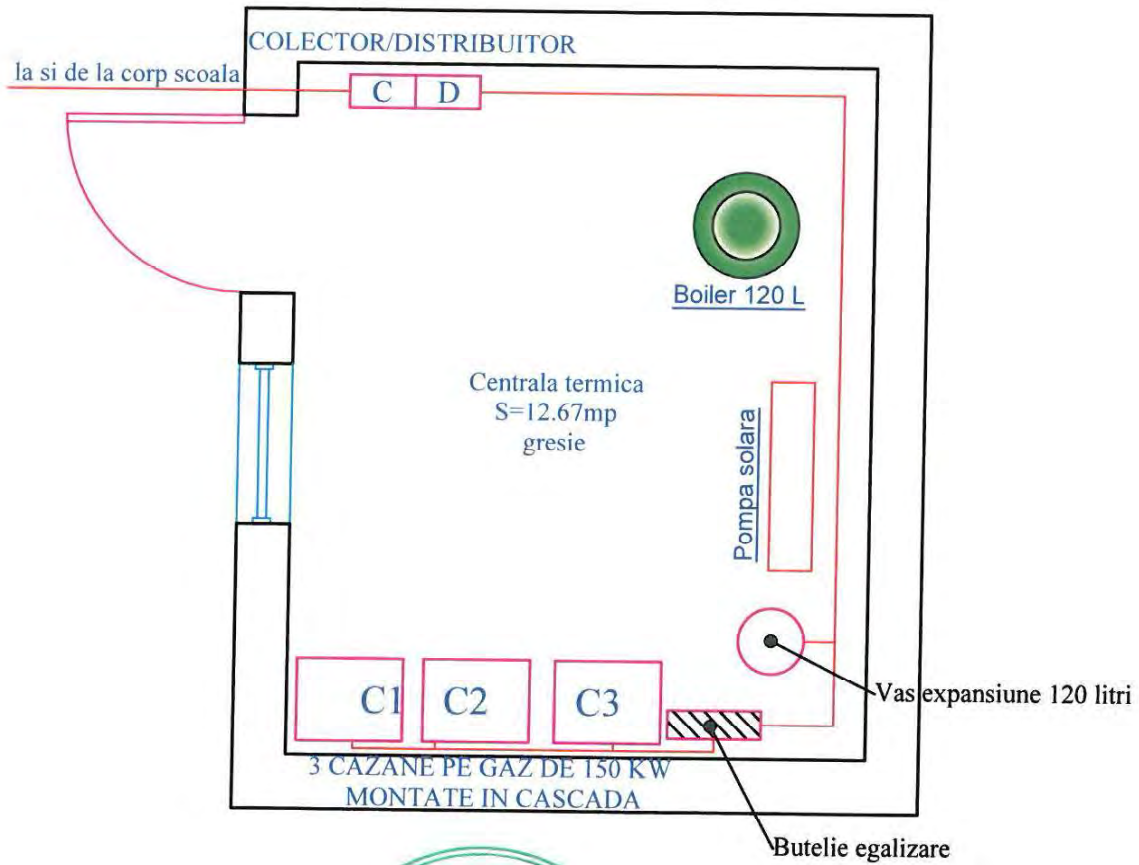

expert teh.		cerinta	expertiza nr.
verificator		cerinta	referat nr.
 <b>DAVIDE EL BRAVO SRL</b> Drobeta Turnu Severin Bulevardul Mihai Viteazul, nr. 2C J25/179/2013, CUI: RO31700497		Beneficiar: U.A.T. - DROBETA TURNU SEVERIN	
		Reabilitare gradinita cu PP nr.22 din municipiul Drobeta Turnu Severin	
SEF PROIECT	Ing. Nicoli Petrisor	scara 1:50	pr.nr. 34/2022
PROIECTAT	Ing. Nicoli Petrisor	data 2022	faza D.A.L.I.
DESENAT	Ing. Bobiti Patricia		plansa IT 04